



**THERMORY**

Excellence in Wood

SUPERIOR QUALITY REAL WOOD

Sauna materials and elements



## Looking good, feeling better – welcome to a world of wellness, relaxation, and beauty

Thermory has been producing superior wood products for over 20 years, and we offer a complete range of high-quality materials, ready-made elements, and accessories for sauna design. Whether you're looking for a complete sauna that's ready to install or individualized components to custom-build your own dream design, we'll help you create a sauna space that looks great and leaves you feeling energized and refreshed.

**Thermory.** Real wood products that radiate warmth and beauty.

# Explore Thermory's range of sauna products

## 04 We are Thermory

- 05 Our company
- 06 Explore Thermory's sauna range
- 08 Wood types for the sauna
- 14 Benefits of thermal modification
- 16 Wood treatments and finishes

## 19 Designer product series

Make your sauna stand out with luxurious wide boards in thermally modified poplar, radiata pine, and magnolia and attractively embossed natural alder.

- 20 Populus series
- 21 Radiata series
- 22 Magnolia series
- 23 Decora series

## 25 Thermory sauna materials

Create your own unique style with our sauna materials that offer a broad selection of wood species, treatment options, profiles, and sizes.

- 26 Wall panels
- 35 Wall panels with end matching
- 40 Mouldings
- 44 Bench boards
- 45 Bench frontboards

## 47 Thermory ready-made sauna elements

We make it easy to create your perfect sauna with ready-to-use elements including bench sets, floor grids, heater guards, doors, and accessories.

- 48 Bench sets
- 58 Movable benches
- 62 Arm rests, heater guards, and floor grids
- 64 Sauna and bathroom doors
- 74 Sauna accessories

## 76 Installation and maintenance

A guide to installing and maintaining your Thermory sauna.

- 77 Sauna installation guidelines and advice for sauna maintenance
- 79 Suggestions for using intensely thermally modified wood
- 79 Recommended maintenance supplies

## 81 References – saunas love Thermory

### 101 Other products by Thermory

Thermory provides a full range of wood products for cladding, decking, sauna design, and building projects through our collection of market-leading brands.

- 102 AUROOM – ready-made saunas
- 104 THERMORY – thermally modified decking, cladding, and flooring
- 106 SIPARILA – fully finished paneling

## 108 The Thermory reach

# We are Thermory

Delivering superior quality and unrivaled beauty for over

**20** years.



## Our Company

Thermory is the world's largest manufacturer of chemical-free thermally modified timber and sauna materials. Over 90% of our sales are exported to more than 50 countries.

We're dedicated to offering real wood solutions that exceed expectations and enhance environments, and our product portfolio includes decking, cladding, and floorboards made from thermally modified timber and coated wood products for interior and exterior use. We are also a major player in the sauna, spa, and wellness sector; as the world's leading manufacturer of sauna materials and ready-made saunas, Thermory saunas can be found in homes and public spaces worldwide.



## Thermory's sauna solutions

Our broad range of wood species, profiles, and dimensions caters for a variety of styles, offering everything from standard sauna materials to distinctive products with novel designs that allow those with a bolder outlook to create a wellness space that combines convenience and practicality with striking visual features.

With a choice of natural, thermally modified, brushed, and painted wood finishes, our unrivaled range of options will ensure that you can design a sauna experience that's just right for you. And if you're looking for a quick and easy solution, we also offer a wide range of ready-made elements, from wall panels and bench boards to doors and accessories.

All of this means that whatever you look for in a sauna, Thermory is the perfect choice for you.

## Features of our collection

-  **REAL WOOD PRODUCTS**
-  **QUALITY MATERIALS**
-  **SMOOTH FINISH**
-  **ENDLESS COMBINATIONS**
-  **HEALTH BENEFITS**



# Explore Thermory's sauna range

## Standard elements and custom-built materials for the perfect sauna

We have everything you could possibly want for your sauna, all in one place – so there's no need to shop around. With an unrivaled selection of wood species, styles, and sizes as well as various treatment options, you can combine our ready-made elements or design your own materials to create a sauna that's uniquely yours.

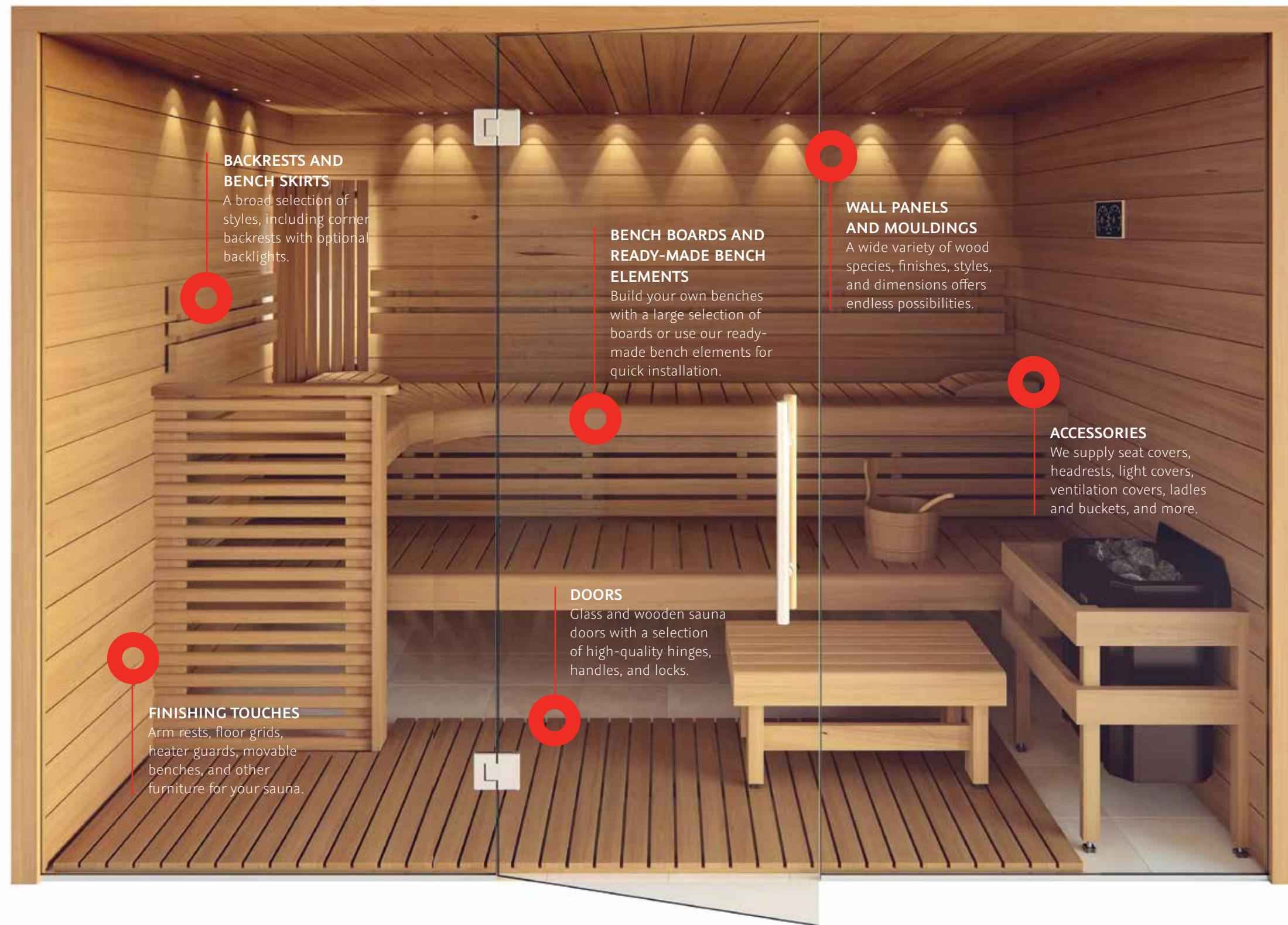

### BACKRESTS AND BENCH SKIRTS

A broad selection of styles, including corner backrests with optional backlights.

### BENCH BOARDS AND READY-MADE BENCH ELEMENTS

Build your own benches with a large selection of boards or use our ready-made bench elements for quick installation.

### WALL PANELS AND MOULDINGS

A wide variety of wood species, finishes, styles, and dimensions offers endless possibilities.

### ACCESSORIES

We supply seat covers, headrests, light covers, ventilation covers, ladles and buckets, and more.

### DOORS

Glass and wooden sauna doors with a selection of high-quality hinges, handles, and locks.

### FINISHING TOUCHES

Arm rests, floor grills, heater guards, movable benches, and other furniture for your sauna.

## Wood types for the sauna

Every sauna design is different – some prioritize practical aspects that will deliver a superior bathing experience, while others focus more on decorative elements and visual appeal. Whatever features you choose for your sauna, there are certain universal principles, like using woods that don't overheat or secrete resin for the benches and selecting interior materials that are resistant to heat and moisture.

- ▶ Here, you can find information about **Thermory's** most popular woods for sauna design

## Common aspen

*(Populus tremula)*

The common aspen is a deciduous tree of the willow family, in the Malpighiales order. It grows across Europe and in most of Asia, as well as northern Africa.

Aspen makes an ideal sauna material because it doesn't secrete resin, create splinters, or get too hot. Its characteristic light tone and smooth texture give it an attractive look and make it perfect for painting. We offer a number of interior sauna elements in both natural and thermally modified aspen.

**WHAT WE USE IT FOR** ▶ Sauna benches, interiors, and exterior paneling

**OPTIONS AVAILABLE** ▶ Natural, thermally modified



NATURAL



THERMALLY MODIFIED

## Common alder or black alder

*(Alnus glutinosa)*

The common alder, also known as black alder, is a perennial deciduous tree in the birch family of the Fagales order. It can be found in most of Europe, southwestern Asia, and northern Africa.

Thanks to its reddish tone and pleasant texture, alder wood is popular as a finishing material in saunas. Alder is hardy and water-repellent, and it doesn't overheat. We use alder to produce a variety of interior sauna materials and products, with thermally modified and brushed finishes available.

**WHAT WE USE IT FOR** ▶ Sauna benches, interiors, and exterior paneling

**OPTIONS AVAILABLE** ▶ Natural, thermally modified, dark thermally modified



NATURAL



THERMALLY MODIFIED



DARK THERMALLY MODIFIED



# Western red cedar

*(Thuja plicata)*

Western red cedar is an evergreen coniferous tree in the cypress family of the Pinales order that grows in the western part of North America.

The western red cedar, also known as Pacific red cedar, is perfect for saunas because it doesn't secrete resin or overheat, and it is also water repellent. Red cedar is known for its pleasantly rich aroma and its exquisite reddish color with a range of natural shades.

**WHAT WE USE IT FOR** ▶ Sauna benches, interiors, and exterior paneling

**OPTIONS AVAILABLE** ▶ Natural



NATURAL

# Canadian hemlock

*(Tsuga canadensis)*

*Tsuga canadensis*, also known as Canadian hemlock or eastern hemlock, is a coniferous tree of the pine family in the Pinales order. It grows in the eastern part of North America.

The wood of *Tsuga canadensis* is soft, with a coarse grain and a light buff color. As well as being durable and knot-free, this wood is ideal for use in saunas because it doesn't warp and it radiates heat evenly. Canadian hemlock also produces a delicate, relaxing aroma.

**WHAT WE USE IT FOR** ▶ Sauna benches, interiors, and exterior paneling

**OPTIONS AVAILABLE** ▶ Natural



NATURAL

# Scots pine

*(Pinus sylvestris)*

The Scots pine is a coniferous tree of the pine family, in the Pinales order. It is the most widespread pine species, and is common across Europe and Asia.

In saunas, Scots pine is most commonly used for outer walls. The wood responds well to thermal modification, producing an exclusive look, and we additionally offer sauna materials in natural Scots pine. The pattern of the wood can also be accentuated through brushing.

**WHAT WE USE IT FOR** ▶ Mainly used for sauna exterior paneling

**OPTIONS AVAILABLE** ▶ Natural, thermally modified



NATURAL



THERMALLY MODIFIED

# Norway spruce

*(Picea abies)*

Norway spruce, or European spruce, is an evergreen coniferous tree of the pine family in the Pinales order. It grows in northern, central, and eastern Europe.

The wood of the Norway spruce is almost white, with a light yellowish undertone – it is one of the lightest coniferous woods. Spruce is often used as timber, and for saunas it is generally preferred for outer walls. We can also brush the wood to further enhance its attractive natural pattern.

**WHAT WE USE IT FOR** ▶ Mainly used for sauna exterior paneling

**OPTIONS AVAILABLE** ▶ Natural, thermally modified



NATURAL



THERMALLY MODIFIED

# American ash or white ash

(*Fraxinus americana*)

American ash is a perennial deciduous tree of the olive family, in the Lamiales order that grows in North America.

American ash wood is valuable, durable, strong, and decorative, with an attractive texture that beautifully complements exterior sauna walls. Our thermally modified ash takes on a dark brown color, giving an exclusive look, and it can be brushed to further highlight its distinctive pattern.

**WHAT WE USE IT FOR** ▶ Mainly used for sauna exterior paneling

**OPTIONS AVAILABLE** ▶ Thermally modified



THERMALLY MODIFIED

# Poplar

(*Populus*)

Poplar belongs to the same genus as aspen (*Populus tremula*) and it is part of the willow family. It is commonly found across most of the Northern Hemisphere.

Poplar is naturally pale yellow in color, with a smooth texture. Being similar to aspen, it's perfect for the sauna – the wood has no exposed knots and it doesn't splinter, secrete resin, or overheat. Wide boards and the warm look provided by thermal modification make for a luxurious, cozy finish.

**WHAT WE USE IT FOR** ▶ Sauna benches, interiors, and exterior paneling

**OPTIONS AVAILABLE** ▶ Thermally modified



THERMALLY MODIFIED

# Magnolia

(*Liriodendron tulipifera*)

Magnolia, also known as the tulip tree, belongs to the magnolia family in the Magnoliales order. It grows mainly in central and eastern parts of North America.

Magnolia has a creamy, golden hue with darker areas, and a characteristic pattern with similarities to ash and radiata pine. Along with its low density, this makes it perfect for the sauna. Wide boards and the dark shade achieved by thermal modification offer a luxurious, exclusive finish.

**WHAT WE USE IT FOR** ▶ Sauna benches, interiors, and exterior paneling

**OPTIONS AVAILABLE** ▶ Thermally modified



THERMALLY MODIFIED

# Clear pine or radiata pine

(*Pinus radiata*)

The radiata pine is a coniferous tree of the pine family, in the Pinales order. It can be seen growing in western North America, New Zealand, Australia, South Africa, Chile, and parts of Europe.

Radiata pine's rapid growth and excellent quality make it among the most cultivated coniferous species. With no exposed knots, the wood doesn't secrete resin, splinter, or overheat, making it great for sauna benches. Wide boards, brushing to bring out the natural pattern, and the darker hue from thermal modification offer an additional touch of luxury.

**WHAT WE USE IT FOR** ▶ Sauna benches, interiors, and exterior paneling

**OPTIONS AVAILABLE** ▶ Thermally modified



THERMALLY MODIFIED



Our thermally modified wood for sauna design undergoes a process that uses a precise combination of heat and steam.

This process is completely natural

**THE HEAT**  
ENHANCES THE WOOD'S  
STRUCTURE THROUGHOUT

**THE STEAM**  
GIVES US FULL CONTROL  
OVER THE PROCESS

Thermally modified timber is our key strength at Thermory. With our exclusive, state-of-the-art technology and years of expertise, we know exactly how to bring out the best in wood.

Thermally modified wood is natural – its properties are enhanced using just heat and steam. This chemical-free process results in an environmentally friendly and aesthetically pleasing material that's significantly more durable and stable than conventional timber.

As well as offering these practical benefits, our thermal modification treatment also creates dynamic visual effects, with the wood taking on an appealing darker brown shade. The intensity of the color depends on the wood type and the duration and temperature of the modification process. This gives you the opportunity to choose between lighter and darker materials to suit your desired color palette.

Thermally modified timber is suitable for interior and exterior use in both homes and public spaces.

## Our thermally modified wood is simply superior



**▶ STABILITY**  
Dimensional stability due to a significantly reduced equilibrium moisture content



**▶ ECO-FRIENDLY**  
The wood is enhanced with our chemical-free modification process



**▶ HIGH DURABILITY**  
Improved durability and a high level of rot resistance



**▶ LIGHTWEIGHT**  
Easy handling and reduced thermal conductivity



**▶ AESTHETIC APPEAL**  
Warm colors that create a cozy atmosphere and a luxurious look

As well as thermal modification, we also offer other treatments for your unique wellness space with brushed, painted, and patterned finishes to choose from.

## Brushing

Brushing emphasizes the natural texture of the wood, giving the panels an elegant look that's normally associated with aged wood. This attractive patterned surface can be further highlighted on cladding and interior walls with creative lighting design.

## Painting

Thermory offers painted boards and panels under our Siparila brand, many of which are ideal for the sauna. The standard colors are brown, gray, black, and white, and you can also try other colors to engage your creative side – just ensure that they're suitable for use in the sauna. Our sales department can provide further information and advice.

## Embossing

We are excited to introduce a new selection of patterned sauna panels and elements. For instance, we offer sauna materials that come embossed with our distinctive Dragon Scale pattern, while the appealing Prairie pattern invokes a sense of rugged nature. Contact our sales team to learn more about product options.

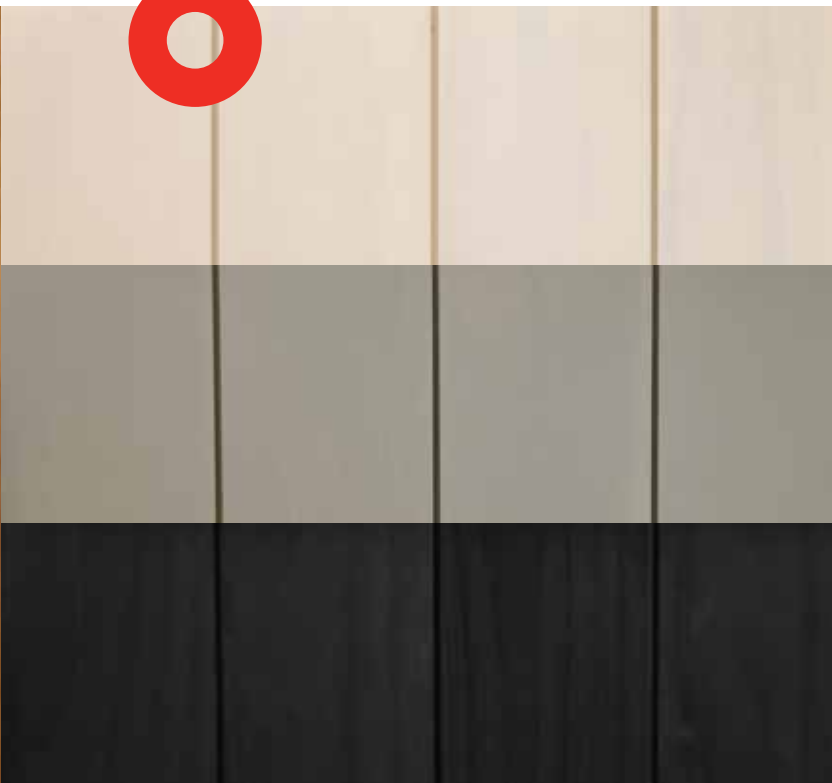





## Designer product series

Our designer product series provide unique characteristics that add a new dimension to your sauna, ensuring that it truly stands out. The Populus, Radiata, and Magnolia series feature wide thermally modified boards for a luxurious design, while the Decora series offers a beautiful patterned effect for an exclusive look.



# Populus series



## STUNNING THERMALLY MODIFIED POPLAR

Thermory's Populus series features poplar as an alternative to aspen that offers similar characteristics, with the option to use wide panels further enhancing its appeal. Thermal modification treatment from Thermory gives the wood a beautiful light brown shade, which lends a warm and cozy feeling to any space in which it's used. If you choose to use a paraffin oil treatment, this will protect the wood and give it a gorgeous darker color.

### PRODUCTS AVAILABLE

- ▶ **SAUNA MATERIALS:** Wall panels and bench boards
- ▶ **READY-MADE ELEMENTS:** Bench modules, bench skirts, backrests, and movable benches

POPLAR,  
BRUSHED



POPLAR,  
OILED  
• To be oiled by customer



# Radiata series

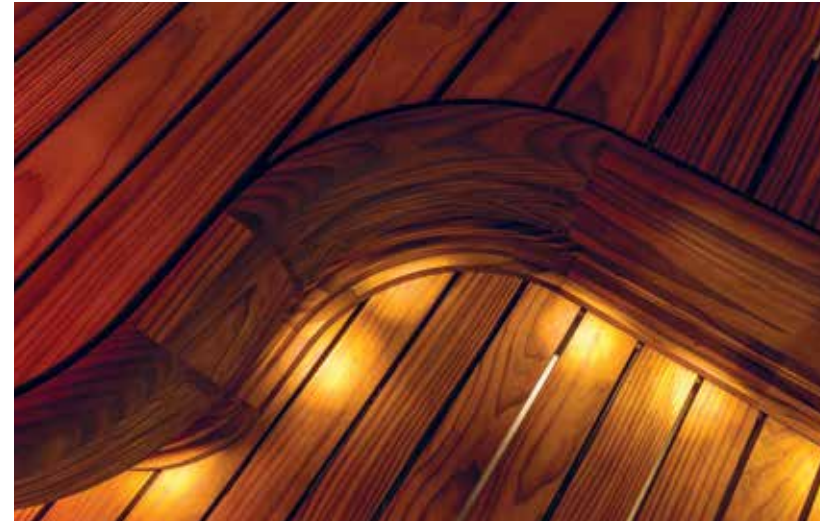

## LUXURIOUS THERMALLY MODIFIED RADIATA PINE

A lightweight wood with a beautiful characteristic pattern, radiata pine makes an excellent sauna material. Our thermal modification treatment gives the wood a dark brown color for a particularly exclusive look, and the distinctive pattern of the wood can be accentuated with brushing. Radiata pine also gives you the option to use wider boards to bring a touch of luxury to your sauna.

### PRODUCTS AVAILABLE

- ▶ **SAUNA MATERIALS:** Wall panels, bench boards, and mouldings
- ▶ **READY-MADE ELEMENTS:** Bench modules, bench skirts, backrests, and movable benches

RADIATA PINE,  
BRUSHED



RADIATA PINE,  
OILED  
• To be oiled by customer

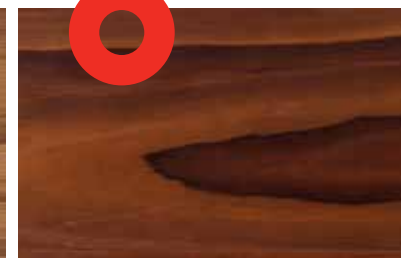

# Magnolia series



## SOLID THERMALLY MODIFIED MAGNOLIA

Magnolia is stronger and more solid than radiata pine and poplar. Natural magnolia has a creamy, golden hue with distinctive darker areas and a characteristic pattern that is reminiscent of ash and radiata pine. This unique look, combined with its low density, makes magnolia a perfect wood for the sauna, with wide boards and the dark shade achieved by thermal modification adding an exclusive, stately finish.

PRODUCTS AVAILABLE

▶ SAUNA MATERIALS: Wall panels and bench boards

MAGNOLIA, BRUSHED



MAGNOLIA, OILED  
• To be oiled by customer



 THERMALLY MODIFIED WOOD

 LUXURIOUS WIDE PANELS

 BRUSHED FINISH AVAILABLE

 ATTRACTIVE, COZY AESTHETIC

# Decora series



## ATTRACTIVE EMBOSSED NATURAL ALDER

Thermory's Decora series makes it possible to create a truly unique sauna design. The boards, which are made from natural alder, are embossed with a pattern that adopts the Dragon Scale pattern used in our popular Ignite range, but without the black finish. This allows you to complete the sauna your way, whether you prefer to stick with standard colors such as white, gray, brown, and black or play around with your color palette for a unique visual effect.

PRODUCTS AVAILABLE

▶ SAUNA MATERIALS: Wall panels and bench boards  
▶ READY-MADE ELEMENTS: Bench modules

EMBOSSED ALDER, PAINTED WHITE  
• To be painted by customer



EMBOSSED ALDER, PAINTED GRAY  
• To be painted by customer



EMBOSSED ALDER, PAINTED BLACK  
• To be painted by customer

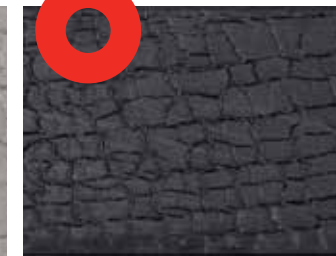

 EMBOSSED NATURAL WOOD

 ATTRACTIVE, COZY AESTHETIC

 PAINT TO YOUR PREFERENCE



# Thermory sauna materials

Create your own  
unique style

We have everything you need to create your own DIY sauna – a massive choice of wood species with various treatment options and a broad selection of profiles and panel sizes from smart and narrow to luxuriously wide. All of this adds up to endless combinations to make sure that your sauna is uniquely designed for you.



# Wall Panels



STP



NEW!

DIM.	BUNDLE	ASPEN	ALDER	SPRUCE	CEDAR	THERMO-ASPEN	THERMO-ALDER	DARK THERMO-ALDER	THERMO-SPRUCE	DRAGON SCALE ALDER
12 x 65	10	VSL0001	VSL0049			VSL0145	VSL0196			
12 x 90	10	VSL0002	VSL0050			VSL0146				
15 x 68	6	VSL0024	VSL0075			VSL0169	VSL0207			
15 x 85	6							VSL0134		
15 x 90	6	VSL0038	VSL0091	VSL0237•		VSL0184	VSL0217		VSL0235•	VSL0491
15 x 120	6							VSL0111		
15 x 125	6	VSL0016	VSL0066			VSL0161	VSL0203			
15 x 140	6				VSL0106					



STS4



NEW! NEW!

DIM.	BUNDLE	ASPEN	ALDER	THERMO-ASPEN	THERMO-ALDER	DARK THERMO-ALDER	THERMO-RADIATA PINE	THERMO-POPLAR	DRAGON SCALE ALDER
12 x 90	6	VSL0004	VSL0053	VSL0148					
15 x 65	6					VSL0125•			
15 x 68	6	VSL0027	VSL0079•	VSL0173	VSL0210•				
15 x 85	6					VSL0037•			
15 x 90	6	VSL0041	VSL0097•	VSL0188	VSL0221•		VSL0231•		
15 x 120	6	VSL0012	VSL0062•	VSL0157	VSL0199•	VSL0115•		VSL0486•	VSL0342
15 x 140	6	VSL0017	VSL0068•	VSL0162	VSL0204•		VSL0229•	VSL0487•	VSL0424
15 x 160	5	VSL0018	VSL0069•	VSL0163	VSL0205•				
19 x 185	4	VSL0045	VSL0101•	VSL0192	VSL0225•		VSL0232•	VSL0488•	



STS3



NEW!

DIMENSIONS	BUNDLE	THERMO-MAGNOLIA
15 x 185	6	VSL0489•

• Also available with a brushed finish



STS3F



NEW!

DIMENSIONS	BUNDLE	THERMO-ASH
12 x 115	6	VSL0477•

• Also available with a brushed finish

# Wall Panels



STS10



**NEW!**

DIMENSIONS	BUNDLE	ASPEN	ALDER	THERMO-ASPEN	THERMO-ALDER	DARK THERMO-ALDER	THERMO-RADIATA PINE	THERMO-MAGNOLIA
12 x 90	10	VSL0003	VSL0052	VSL0147				
15 x 65	6					VSL0124•		
15 x 68	6	VSL0026	VSL0077•	VSL0171	VSL0209•			
15 x 85	6					VSL0036•		
15 x 90	6	VSL0040	VSL0095•	VSL0186	VSL0220•		VSL0230•	
15 x 120	6	VSL0011	VSL0060•	VSL0155	VSL0198•	VSL0114•		
15 x 145	6							VSL0490•
15 x 170	6							VSL0555•

• Also available with a brushed finish



STV



DIMENSIONS	BUNDLE	ASPEN	ALDER	THERMO-ASPEN	THERMO-ALDER	DARK THERMO-ALDER
12 x 90	10	VSL0005	VSL0054	VSL0149		
15 x 65	6					VSL0127•
15 x 68	6	VSL0029	VSL0081•	VSL0175	VSL0212•	
15 x 85	6					VSL0139•
15 x 90	6	VSL0043	VSL0099•	VSL0190	VSL0223•	
15 x 120	6	VSL0014	VSL0064•	VSL0159	VSL0201•	VSL0117•

• Also available with a brushed finish



VIIVA



DIMENSIONS	BUNDLE	ASPEN	ALDER	THERMO-ASPEN	THERMO-ALDER
15x68	6	VSL0031	VSL0083	VSL0177	VSL0214

# Wall Panels



## STP VALEURA

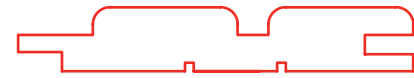

DIMENSIONS	BUNDLE	ASPEN	ALDER	THERMO-ASPEN	THERMO-ALDER	DARK THERMO-ALDER
15 x 65	6					VSL0123
15 x 68	6	VSL0025	VSL0076	VSL0170	VSL0208	
15 x 85	6					VSL0135
15 x 90	6	VSL0039	VSL0094	VSL0185	VSL0219	
15 x 120	6	VSL0010	VSL0059	VSL0154	VSL0197	VSL0112



## STS VALEURA



DIMENSIONS	BUNDLE	ASPEN	ALDER	THERMO-ASPEN	THERMO-ALDER	DARK THERMO-ALDER
15 x 65	6					VSL0126
15 x 68	6	VSL0028	VSL0080	VSL0174	VSL0211	
15 x 85	6					VSL0138
15 x 90	6	VSL0042	VSL0098	VSL0189	VSL0222	
15 x 120	6	VSL0013	VSL0063	VSL0158	VSL0200	VSL0116



## STV VALEURA



DIMENSIONS	BUNDLE	ASPEN	ALDER	THERMO-ASPEN	THERMO-ALDER	DARK THERMO-ALDER
15 x 65	6					VSL0128
15 x 68	6	VSL0030	VSL0082	VSL0176	VSL0213	
15 x 85	6					VSL0140
15 x 90	6	VSL0044	VSL0100	VSL0191	VSL0224	
15 x 120	6	VSL0015	VSL0065	VSL0160	VSL0202	VSL0118



## SIS



DIMENSIONS	BUNDLE	ASPEN	ALDER	THERMO-ASPEN
15 x 68	6	VSL0023	VSL0074	VSL0168
15 x 90	6	VSL0037	VSL0090	VSL0183



# Wall Panels



SRP



DIMENSIONS	BUNDLE	ASPEN	ALDER	THERMO-ASPEN
15 x 82	6	VSL0032	VSL0084	VSL0178



SLP



DIMENSIONS	BUNDLE	ASPEN	ALDER
15 x 90	6	VSL0263	VSL0273



STEP



DIMENSIONS	BUNDLE	ASPEN	ALDER	THERMO-ASPEN	THERMO-ALDER	DARK THERMO-ALDER
27 x 64	4	VSL0047	VSL0104	VSL0194	VSL0227	VSL0143



ROMBTO



DIMENSIONS	BUNDLE	ASPEN	ALDER	THERMO-ASPEN	THERMO-ALDER	DARK THERMO-ALDER
27 x 90	4	VSL0048	VSL0105	VSL0195	VSL0228	VSL0144



UNEDGED PLANK

DIMENSIONS	BUNDLE	ALDER	DARK THERMO-ALDER
18 x 120-250	1		VSL0141
22 x 120-250	1	VSL0103	

► Please contact our sales department for information about available lengths and special-order products



# Wall panels with end matching

Create your own unique pattern – the options are endless!



- ▶ **SUITABLE FOR A RANGE OF APPLICATIONS**  
Our wall panels with end matching can be used for saunas and other indoor rooms
- ▶ **CHOOSE FROM A BROAD SELECTION OF MATERIALS**  
Woods available include natural and thermally modified aspen and alder
- ▶ **GET INSPIRED AND CREATE SOMETHING UNIQUE**  
Combine different lengths and widths, and play around with colors, textures, and angles



ALDER, BRUSHED



DARK THERMO-ALDER, BRUSHED



ASPEN

ALDER

THERMO-ASPEN

DARK THERMO-ALDER

## Convenient to buy, simple to install

Our end-matched wall panels come packed in boxes, and they're as easy to install as regular wall panels; just pay attention to the distances between the counter battens.



▶ You can find a detailed installation guide in the package and at [thermory.com](http://thermory.com)



STF



DIMENSIONS	PANELS PER BOX	COVERAGE PER BOX (M <sup>2</sup> )	ASPEN	ALDER	THERMO-ASPEN	DARK THERMO-ALDER
15 x 65 x 293	64	1	VSL0021	VSL0072•	VSL0166	VSL0121•
15 x 65 x 578	32	1	VSL0020	VSL0071•	VSL0165	VSL0120•
15 x 65 x 1148	16	1	VSL0019	VSL0070•	VSL0164	VSL0119•
15 x 85 x 293	64	1.37	VSL0035	VSL0087•	VSL0181	VSL0132•
15 x 85 x 578	32	1.37	VSL0034	VSL0086•	VSL0180	VSL0131•
15 x 85 x 1148	16	1.37	VSL0033	VSL0085•	VSL0179	VSL0130•
15 x 120 x 293	32	1	VSL0007	VSL0056•	VSL0151	VSL0108•
15 x 120 x 578	16	1	VSL0006	VSL0055•	VSL0150	VSL0107•
15 x 120 x 1148	8	1	VSL0009	VSL0058•	VSL0153	VSL0110•

• Also available with a brushed finish

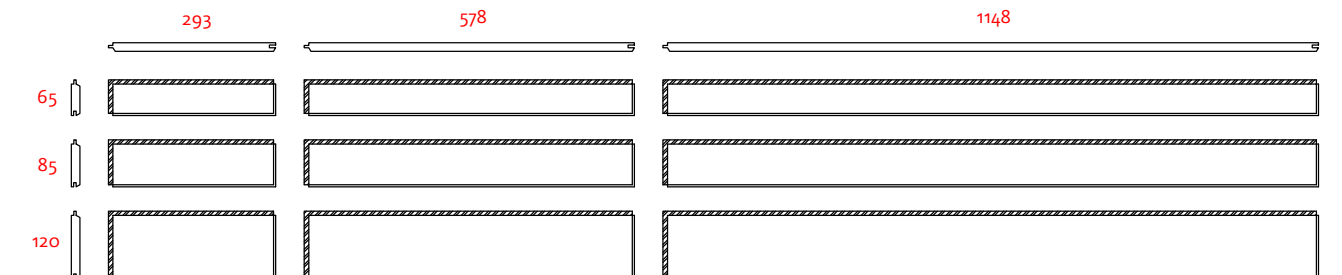



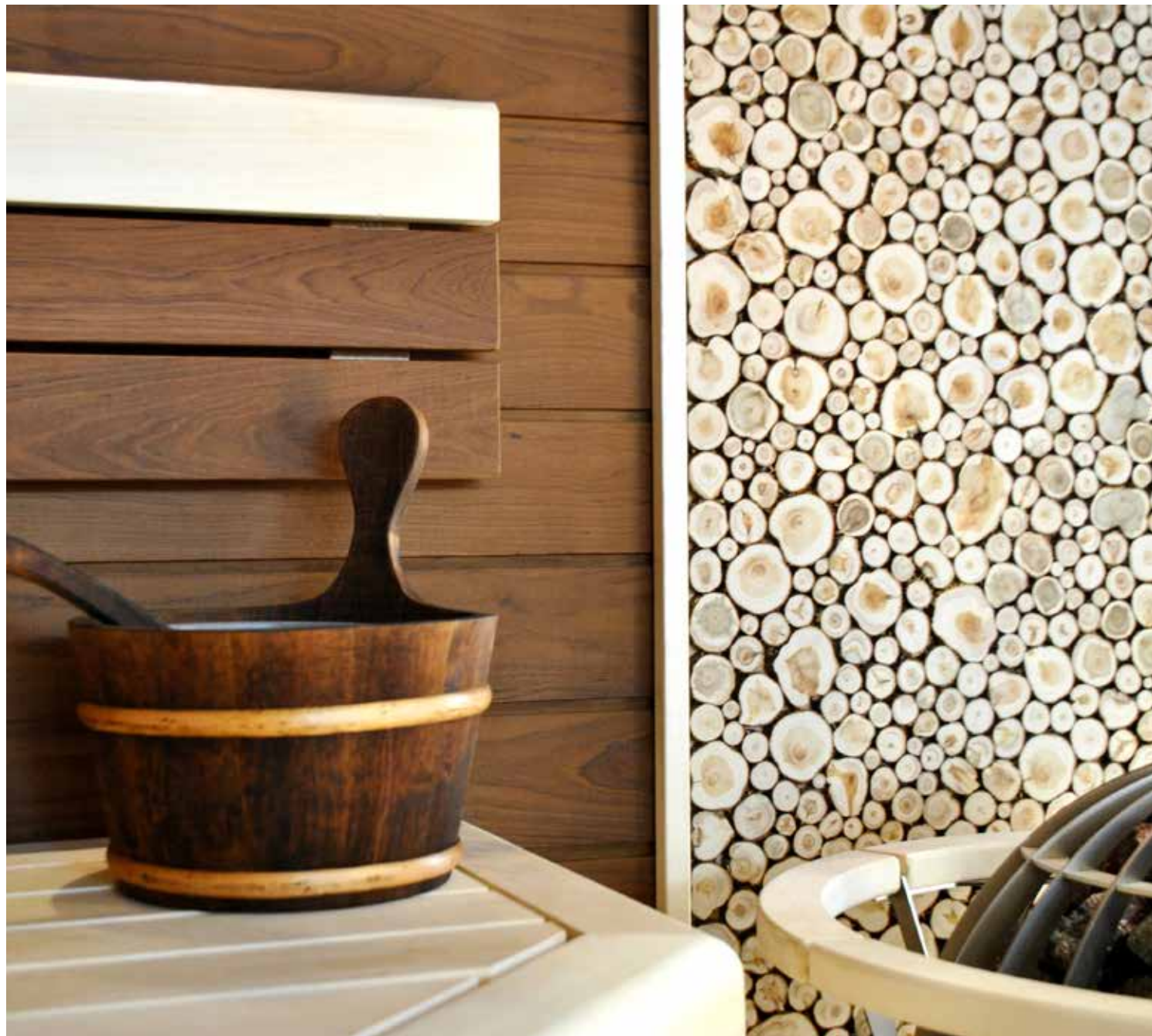

## A feast for your senses

Juniper is a very special wood – dense, strong, and naturally attractive thanks to its annual growth rings with an appealing aroma that remains with the wood for a long time. This aroma is further accentuated by heat and steam, and the fragranced air also carries protective health benefits, making juniper the perfect sauna material.

Thermory juniper plate is a unique design element that's both attractive and aromatic. It can be used as a feature wall in your sauna in combination with other panel types. With its naturally distinctive pattern, pleasant aroma, and decorative appeal, a juniper plate will give your relaxation space its own unique look, feel, and scent.

Decorative Juniper plate

DIMENSIONS	PRODUCT CODE
21 x 250 x 1000	STO0012
21 x 250 x 1500	STO0147
21 x 500 x 500	STO0001
21 x 500 x 1000	STO0002
21 x 500 x 1500	STO0003



- ▶ Juniper plate can also be ordered in custom sizes – please contact our sales department for more information

# Mouldings

Thermory's selection of sauna mouldings serves a variety of purposes – covering gaps, filling in corners, and rounding off the visual theme. Whether you're after a traditionally decorative style or a standard look, Thermory has you covered.



UK



DIMENSIONS	BUNDLE	ASPEN	ALDER	THERMO-ASPEN	DARK THERMO-ALDER	THERMO-RADIATA PINE
12 x 42	10	VL10001	VL10023	VL10048	VL10045*	VL10070*

\* 5 pcs in bundle



KA



DIMENSIONS	BUNDLE	ASPEN	ALDER	THERMO-ASPEN	DARK THERMO-ALDER
14 x 60	5	VL10005	VL10028	VL10052	VL10047



SHP



DIMENSIONS	BUNDLE	ASPEN	ALDER	THERMO-ASPEN
15 x 45	10	VL10009	VL10031	VL10056



SHP



DIMENSIONS	BUNDLE	ASPEN	ALDER	THERMO-ASPEN	THERMO-RADIATA PINE
21 x 21	10	VL10014	VL10036	VL10061	VL10073



SHA



DIMENSIONS	BUNDLE	ASPEN	ALDER	THERMO-ASPEN
16 x 42	8	VL10011	VL10033	VL10058



SHA



DIMENSIONS	BUNDLE	ASPEN	ALDER	THERMO-ASPEN
20 x 40	4	VL10012	VL10034	VL10059

# Mouldings



VÄ

DIMENSIONS	BUNDLE	ASPEN	ALDER	THERMO-ASPEN	THERMO-RADIATA PINE
21 x 42	10	VLl0015	VLl0037	VLl0062	VLl0074*
28 x 28	20	VLl0019	VLl0041	VLl0066	
28 x 42	10	VLl0021	VLl0043	VLl0068	
40 x 40	1	LPV0017	LPV0016	LPV0027	

\* 4 pcs in bundle



SI

DIMENSIONS	BUNDLE	ASPEN	ALDER	THERMO-ASPEN	THERMO-RADIATA PINE
15 x 18	15	VLl0007	VLl0029	VLl0054	VLl0072*

\* 4 pcs in bundle



SI

DIMENSIONS	BUNDLE	ASPEN	ALDER	THERMO-ASPEN	DARK THERMO-ALDER	THERMO-RADIATA PINE
14 x 30	20	VLl0003	VLl0025	VLl0050	VLl0046*	VLl0071*

\* 4 pcs in bundle



SI

DIMENSIONS	BUNDLE	ASPEN	ALDER	THERMO-ASPEN
25 x 25	10	VLl0017	VLl0039	VLl0064

# Cover mouldings for wall panel joints



KA

Fixing of KA-mouldings

DIMENSIONS	BUNDLE	ASPEN	ALDER	THERMO-ASPEN	DARK THERMO-ALDER
8 x 34	5	VLl0091	VLl0092	VLl0093	VLl0094
8 x 65	5	VLl0095	VLl0096	VLl0097	VLl0098

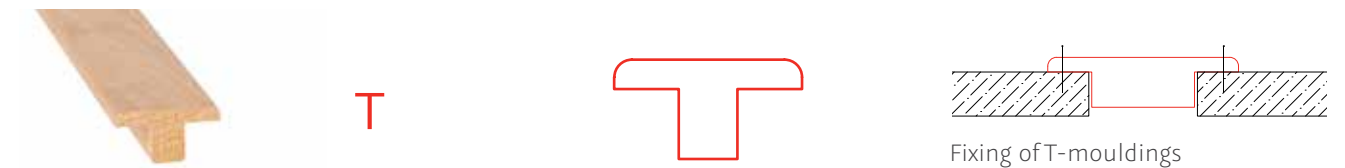

T

Fixing of T-mouldings

DIMENSIONS	BUNDLE	ASPEN	ALDER	THERMO-ASPEN
17 x 32	5	VLl0099	VLl0100	VLl0101
17 x 63	5	VLl0102	VLl0103	VLl0104

These mouldings are ideal when you need to use shorter wall panels in your sauna space. Our KA mouldings can also be used as a supplementary design element, for instance by offsetting a light-colored wall with a darker tone or vice versa. The mouldings can be fitted with finishing nails or decorative nails.



T-moulding, alder, 17 x 65 mm



KA-mouldings, thermo-aspen, 8 x 34 and 8 x 65 mm



# Bench boards



SHP



**NEW! NEW! NEW!**

DIMENSIONS	BUNDLE	ASPEN	ALDER	CEDAR	THERMO-ASPEN	THERMO-ALDER	DARK THERMO-ALDER	THERMO-RADIATA PINE	THERMO-POPLAR	THERMO-MAGNOLIA	DRAGON SCALE ALDER
21 x 65	5	VLL0001	VLL0014		VLL0035						
21 x 90	5	VLL0002	VLL0015		VLL0036	VLL0190					
26 x 90	4			VLL0053							
26 x 92	4							VLL0052			
26 x 140	4			VLL0027				VLL0050	VLL0332		
26 x 185	3							VLL0051	VLL0333		
27 x 42	8						VLL0032				
27 x 65	4						VLL0033				
27 x 85	4						VLL0034				
27 x 115	4						VLL0028				
27 x 135	4						VLL0029				
28 x 42	8	VLL0008	VLL0020		VLL0042						
28 x 65	4	VLL0010	VLL0021		VLL0043						
28 x 90	4	VLL0012	VLL0022		VLL0044	VLL0187					VLL0223
28 x 120	4	VLL0004	VLL0016		VLL0037	VLL0191					
28 x 140	4	VLL0005	VLL0017		VLL0038	VLL0192					
28 x 160	3	VLL0006	VLL0018		VLL0039						
28 x 185	3									VLL0334	



# Bench frontboards



SHA



DIMENSIONS	BUNDLE	ASPEN	ALDER	THERMO-ASPEN	THERMO-RADIATA PINE
28 x 90	2	VLL0105	VLL0090	VLL0106	
54 x 135	1				LPV0014



SHA



DIMENSIONS	BUNDLE	ASPEN	ALDER	THERMO-ASPEN
42 x 88	2	LPV0003	LPV0007	LPV0012



SHA



DIMENSIONS	BUNDLE	ASPEN	ALDER	THERMO-ASPEN
80 x 108	2	LPV0004	LPV0008	LPV0013



SHP



DIMENSIONS	BUNDLE	ASPEN	ALDER	THERMO-ASPEN
68 x 68	1	LPV0031	LPV0030	LPV0032
86 x 86	1	LPV0037	LPV0036	LPV0038



SHA



DIMENSIONS	BUNDLE	ASPEN	ALDER	THERMO-ASPEN
40 x 90	2	LPV0002	LPV0006	LPV0011
40 x 140	2	LPV0001	LPV0005	LPV0010
40 x 190	2	LPV0033	LPV0034	LPV0035

## BENCH CORNER PIECES

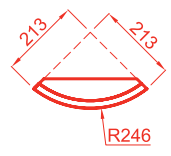
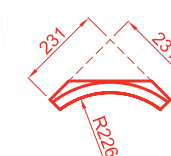
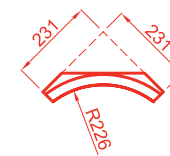

	DIMENSIONS	BUNDLE	ASPEN	ALDER	THERMO-ASPEN
Inner arch	28 x 90	1	ST0283	ST0282	ST0284
Inner arch	40 x 140	1	ST0146	ST0145	ST0147
Outer arch	40 x 140	1	ST0158	ST0157	ST0159



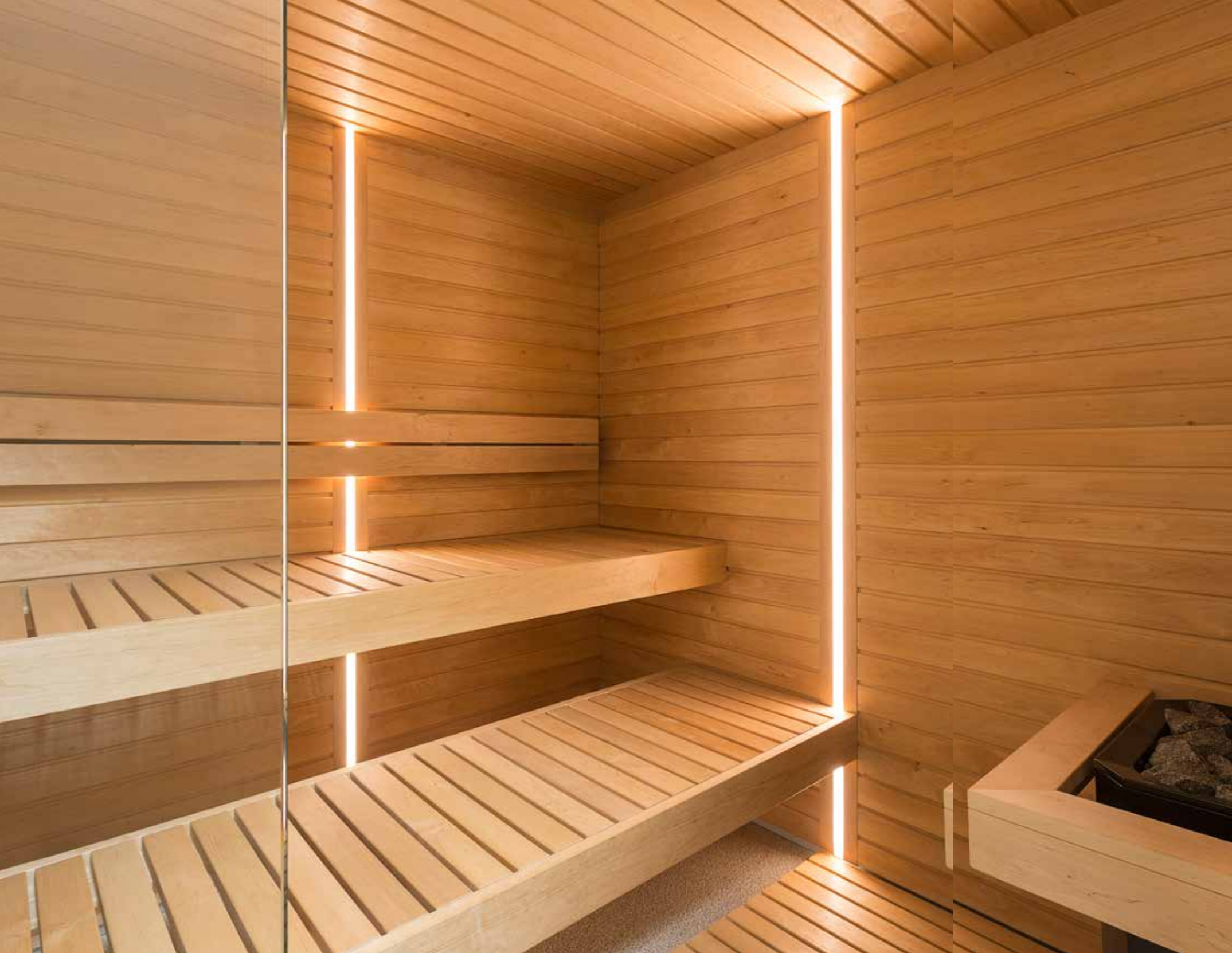

# Thermory ready-made sauna elements

We make it easy for you

Create your perfect wellness and relaxation space with our ready-to-use sauna elements. With bench sets, floor grids, and heater guards as well as doors and other accessories, all you need to do is select your favorite items to put the finishing touches on your sauna.

# Bench module set Nona 90

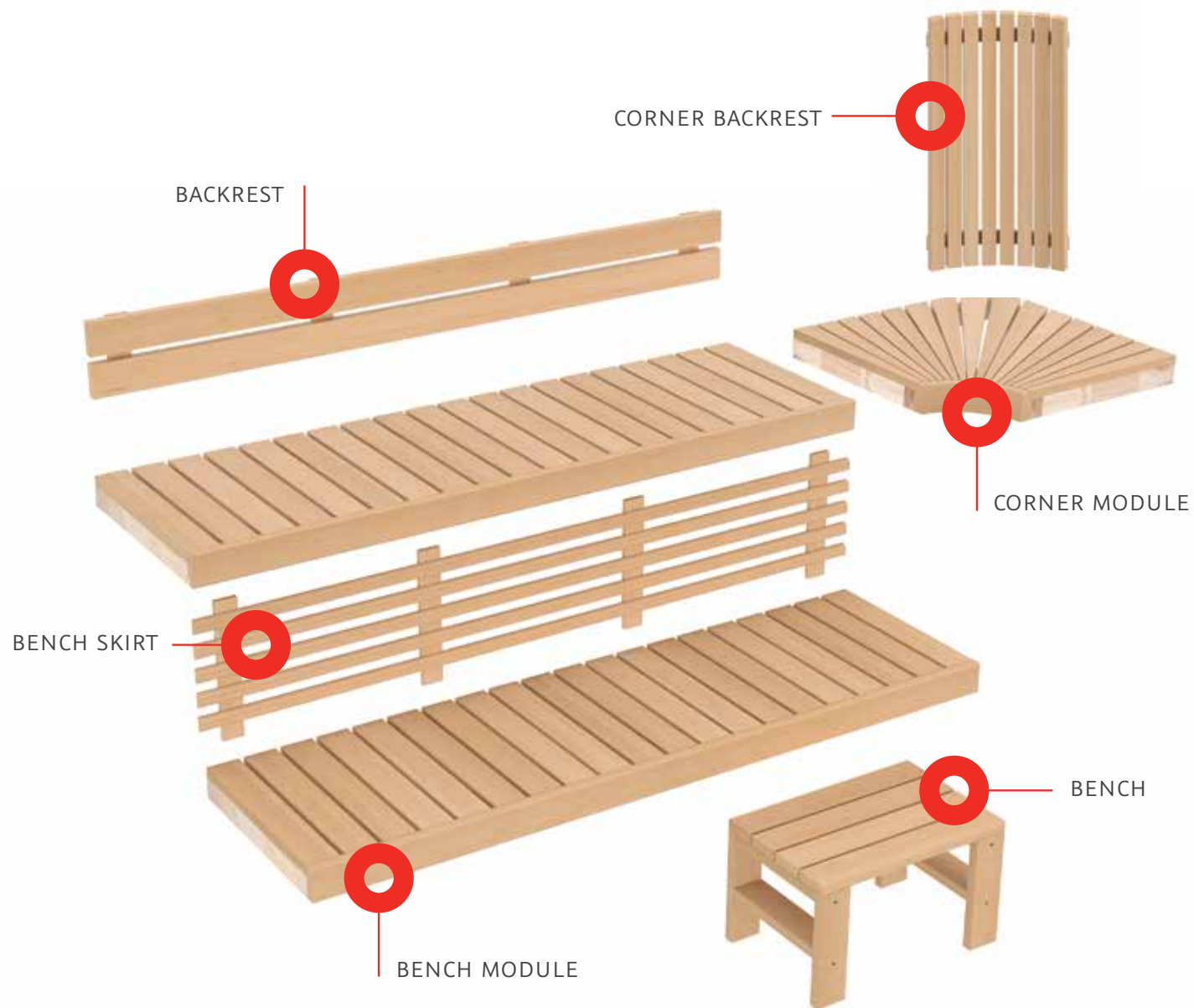

## BENCH MODULES

DIMENSIONS	ASPEN	ALDER	THERMO-ASPEN
600 x 1800	STo218	STo208	STo228
600 x 2100	STo216	STo206	STo226
600 x 2400	STo214	STo204	STo224
500 x 2100	STo825	ST3373	ST3042
400 x 1800	STo219	STo209	STo229
400 x 2100	STo217	STo207	STo227
400 x 2400	STo215	STo205	STo225

## CORNER MODULES

DIMENSIONS	ASPEN	ALDER	THERMO-ASPEN
600 x 600	STo222	STo212	STo232
500 x 500	ST1014	ST1573	ST1033
400 x 400	STo223	STo213	STo233

## BENCH SKIRTS

DIMENSIONS	ASPEN	ALDER	THERMO-ASPEN
14 x 300 x 1800	STo336	STo332	STo340
14 x 300 x 2100	STo335	STo331	STo339
14 x 300 x 2400	STo334	STo330	STo338

## BACKRESTS

DIMENSIONS	ASPEN	ALDER	THERMO-ASPEN
28 x 200 x 1750	STo312	STo308	STo316
28 x 200 x 2050	STo311	STo307	STo315
28 x 200 x 2350	STo310	STo306	STo314

## CORNER BACKRESTS

DIMENSIONS	ASPEN	ALDER	THERMO-ASPEN
28 x 400 x 850	STo304	STo303	STo305

## BENCHES

DIMENSIONS (DxWxH)	ASPEN	ALDER	THERMO-ASPEN
28 / 380 x 580 x 350	STo948	ST1493	ST2037

Thermory's sauna bench sets are all available with matching backrests and bench skirts. However, it's also possible to create your own combination from multiple sets – all we need is the product code and wood type for each item. We additionally offer a large selection of movable benches, which you can find on the pages that follow.



# Bench module set Carena 140

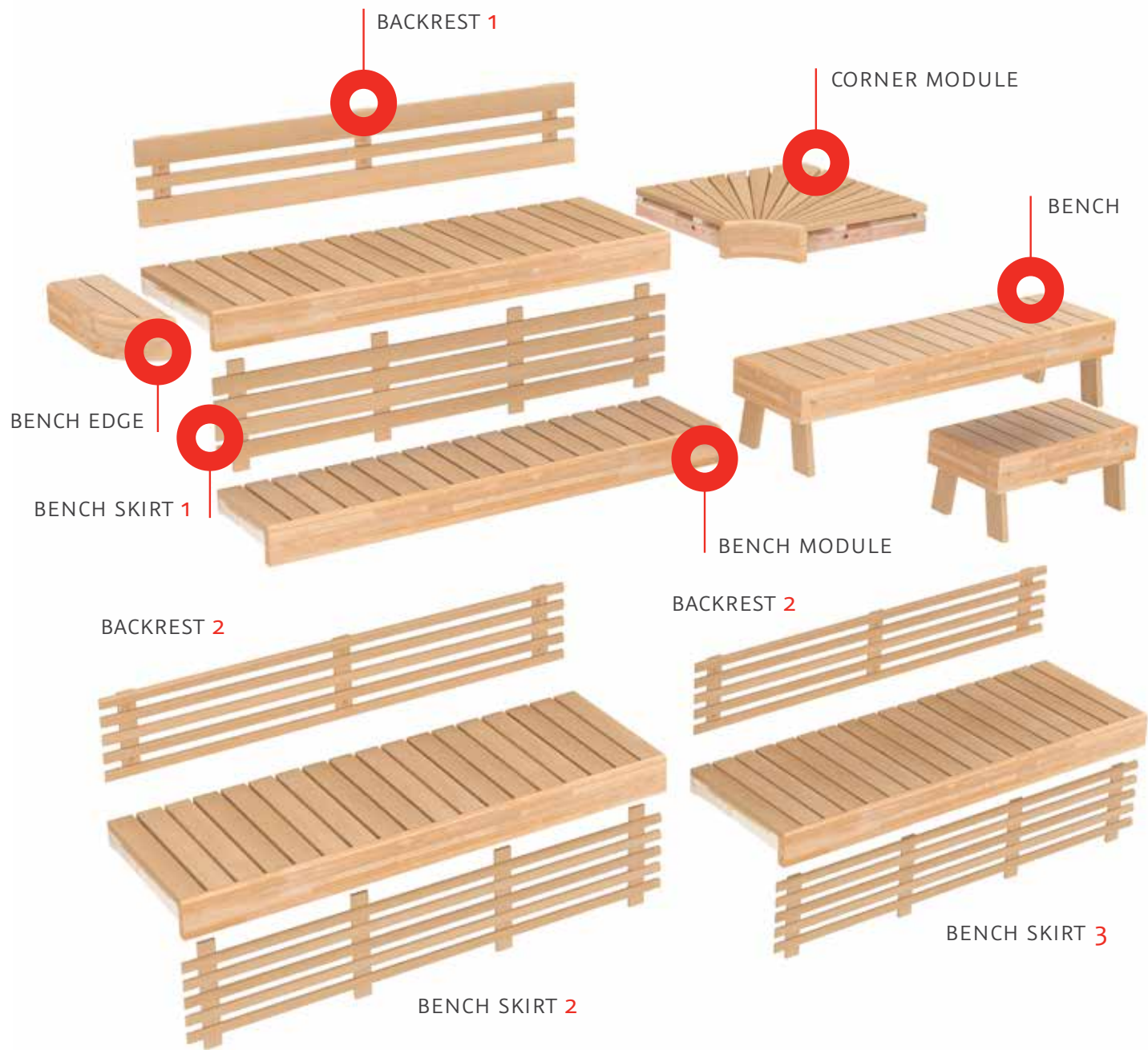

## BENCH MODULES

DIMENSIONS	ASPEN	ALDER	THERMO-ASPEN
600 x 1800	ST0087	ST0077	ST0097
600 x 2100	ST0085	ST0075	ST0095
600 x 2400	ST0083	ST0073	ST0093
500 x 2100	ST0184	ST0179	ST0189
400 x 1800	ST0088	ST0078	ST0098
400 x 2100	ST0086	ST0076	ST0096
400 x 2400	ST0084	ST0074	ST0094

## CORNER MODULES

DIMENSIONS	ASPEN	ALDER	THERMO-ASPEN
600 x 600	ST0091	ST0081	ST0101
500 x 500	ST0187	ST0182	ST0192
400 x 400	ST0092	ST0082	ST0102

## BENCH SKIRTS

DIMENSIONS	ASPEN	ALDER	THERMO-ASPEN
<b>1</b>			
15 x 300 x 1800	ST0505	ST0501	ST0509
15 x 300 x 2100	ST0504	ST0500	ST0508
15 x 300 x 2400	ST0503	ST0499	ST0507
<b>2</b>			
16 x 300 x 1800	ST0133	ST0129	ST0137
16 x 300 x 2100	ST0132	ST0128	ST0136
<b>3</b>			
16 x 350 x 1800	ST0493	ST0489	ST0497
16 x 350 x 2100	ST0492	ST0488	ST0496
16 x 350 x 2400	ST0491	ST0487	ST0495

## BENCH EDGES

DIMENSIONS	ASPEN	ALDER	THERMO-ASPEN
200 x 600 R	ST0107	ST0103	ST0111
200 x 600 L	ST0108	ST0104	ST0112
200 x 500 R	ST3374	ST2934	ST2936
200 x 500 L	ST2695	ST2935	ST2937
200 x 400 R	ST0109	ST0105	ST0113
200 x 400 L	ST0110	ST0106	ST0114

R / L – right-hand edge / left-hand edge of the bench (when seated)

## BACKRESTS

DIMENSIONS	ASPEN	ALDER	THERMO-ASPEN
<b>1</b>			
28 x 300 x 1750	ST0121	ST0117	ST0125
28 x 300 x 2050	ST0120	ST0116	ST0124
28 x 300 x 2350	ST0119	ST0115	ST0123
<b>2</b>			
16 x 300 x 1750	ST0324	ST0320	ST0328
16 x 300 x 2050	ST0323	ST0319	ST0327
16 x 300 x 2350	ST0322	ST0318	ST0326

## BENCHES

DIMENSIONS (DxWxH)	ASPEN	ALDER	THERMO-ASPEN
140 / 400 x 700 x 350	ST0140	ST0139	ST0141
140 / 400 x 1500 x 350	ST0536	ST0535	ST0537

## CORNER BACKRESTS

DIMENSIONS	ASPEN	ALDER	THERMO-ASPEN
28 x 400 x 850	ST0304	ST0303	ST0305



# Bench module set Bessa 108

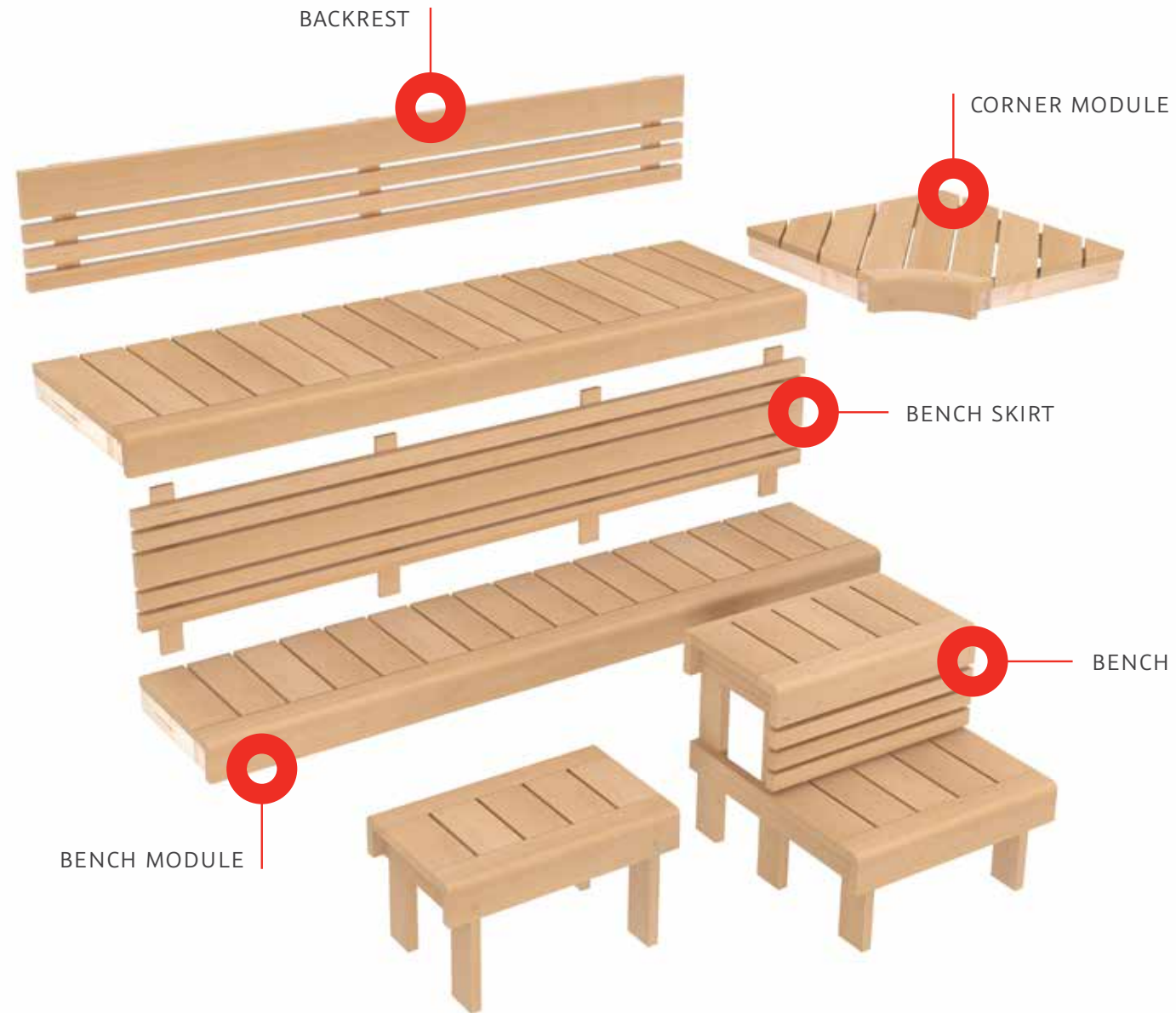

## BENCH MODULES

DIMENSIONS	ASPEN	ALDER	THERMO-ASPEN
600 x 2050	ST1149	ST1157	ST1141
500 x 2050	ST2448	ST2447	ST2449
400 x 2050	ST2856	ST1158	ST1142

## CORNER MODULES

DIMENSIONS	ASPEN	ALDER	THERMO-ASPEN
600 x 600	ST1153	ST1161	ST1145
400 x 400	ST1154	ST1162	ST1146

## BENCH SKIRTS

DIMENSIONS	ASPEN	ALDER	THERMO-ASPEN
28 x 320 x 1750	ST2859	ST1177	ST1171
28 x 320 x 2050	ST2861	ST3367	ST1172
28 x 320 x 2350	ST2713	ST2697	ST1173

## BACKRESTS

DIMENSIONS	ASPEN	ALDER	THERMO-ASPEN
28 x 310 x 1750	ST2845	ST3234	ST1183
28 x 310 x 2050	ST2846	ST1190	ST1184
28 x 310 x 2350	ST2712	ST2698	ST1185

## BENCHES

DIMENSIONS (DxWxH)	ASPEN	ALDER	THERMO-ASPEN
108 / 380 x 640 x 360	ST1196	ST1197	ST1195
108 / 700 x 640 x 600	ST3368	ST3369	ST3370

## Bench module set Capto 178

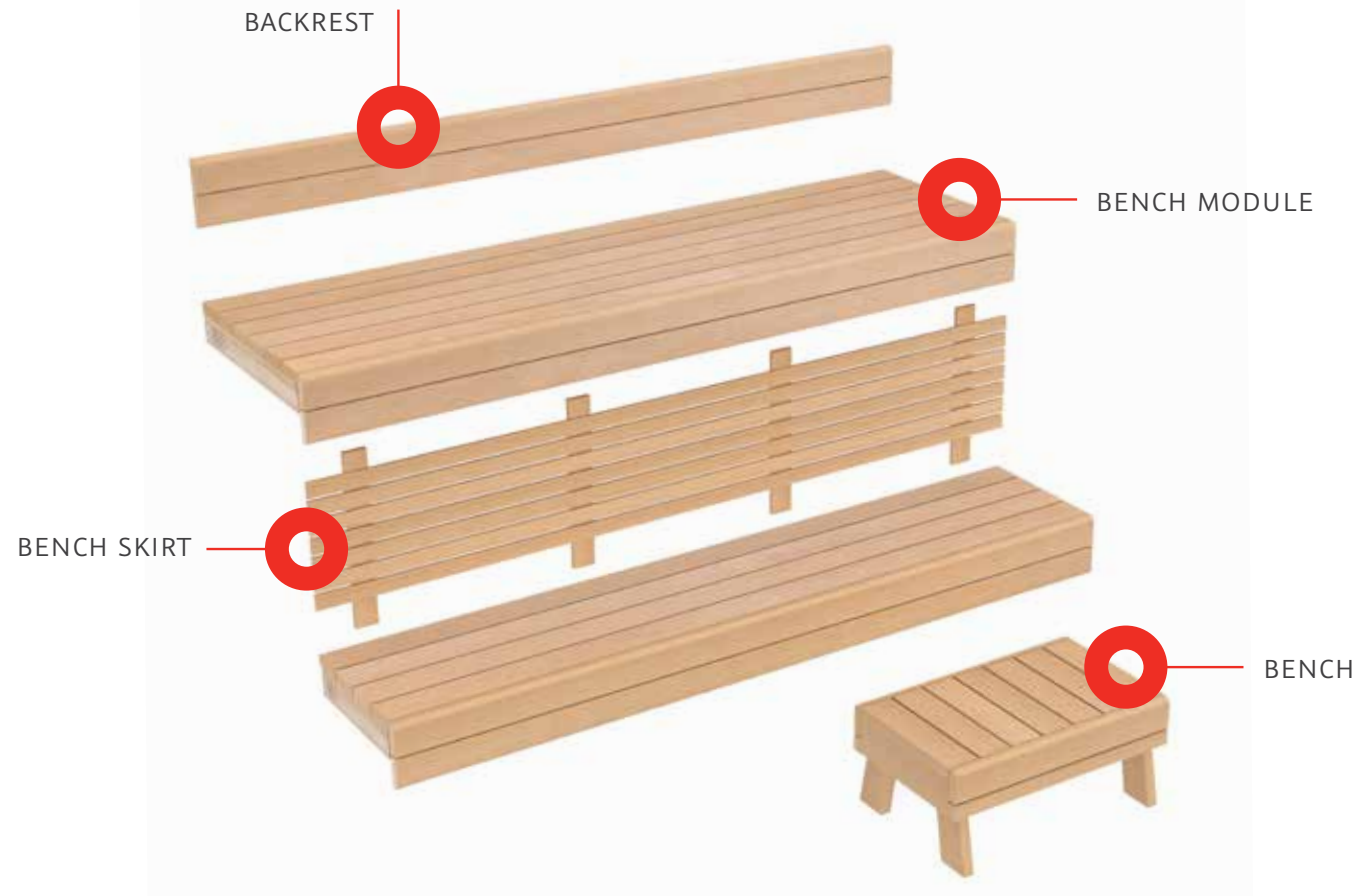

### BENCH MODULES

DIMENSIONS	ASPEN	ALDER	THERMO-ASPEN
600 x 2350	ST2343	ST1725	ST2460
408 x 2350	ST2344	ST1726	ST2461

### BENCH SKIRTS

DIMENSIONS	ASPEN	ALDER	THERMO-ASPEN
12 x 342 x 2350	ST1803	ST1804	ST1805

### BACKRESTS

DIMENSIONS	ASPEN	ALDER	THERMO-ASPEN
28 x 178 x 2350	ST3371	ST2039	ST3372

### BENCHES

DIMENSIONS (DxWxH)	ASPEN	ALDER	THERMO-ASPEN
134 / 400 x 657 x 300	ST2738	ST2821	ST2766

## Bench module set Radiata 135



### BENCH MODULES

DIMENSIONS	THERMO-RADIATA PINE
654 x 1800	ST2841
654 x 2100	ST2908
654 x 2400	ST2772
504 x 1800	ST2771
504 x 2100	ST2759
504 x 2400	ST2966

### BENCH SKIRTS

DIMENSIONS	THERMO-RADIATA PINE
42 x 317 x 1800	ST1180
42 x 317 x 2100	ST2833
42 x 317 x 2400	ST2828

### CORNER MODULES

DIMENSIONS	THERMO-RADIATA PINE
654 x 654	ST1169
504 x 504	ST1170

### BACKRESTS

DIMENSIONS	THERMO-RADIATA PINE
42 x 290 x 1750	ST2961
42 x 290 x 2050	ST2834
42 x 290 x 2350	ST2716

### BENCHES

DIMENSIONS (DxWxH)	THERMO-RADIATA PINE
135 / 412 x 678 x 300	ST2739

# Bench module set Populus 140

NEW!

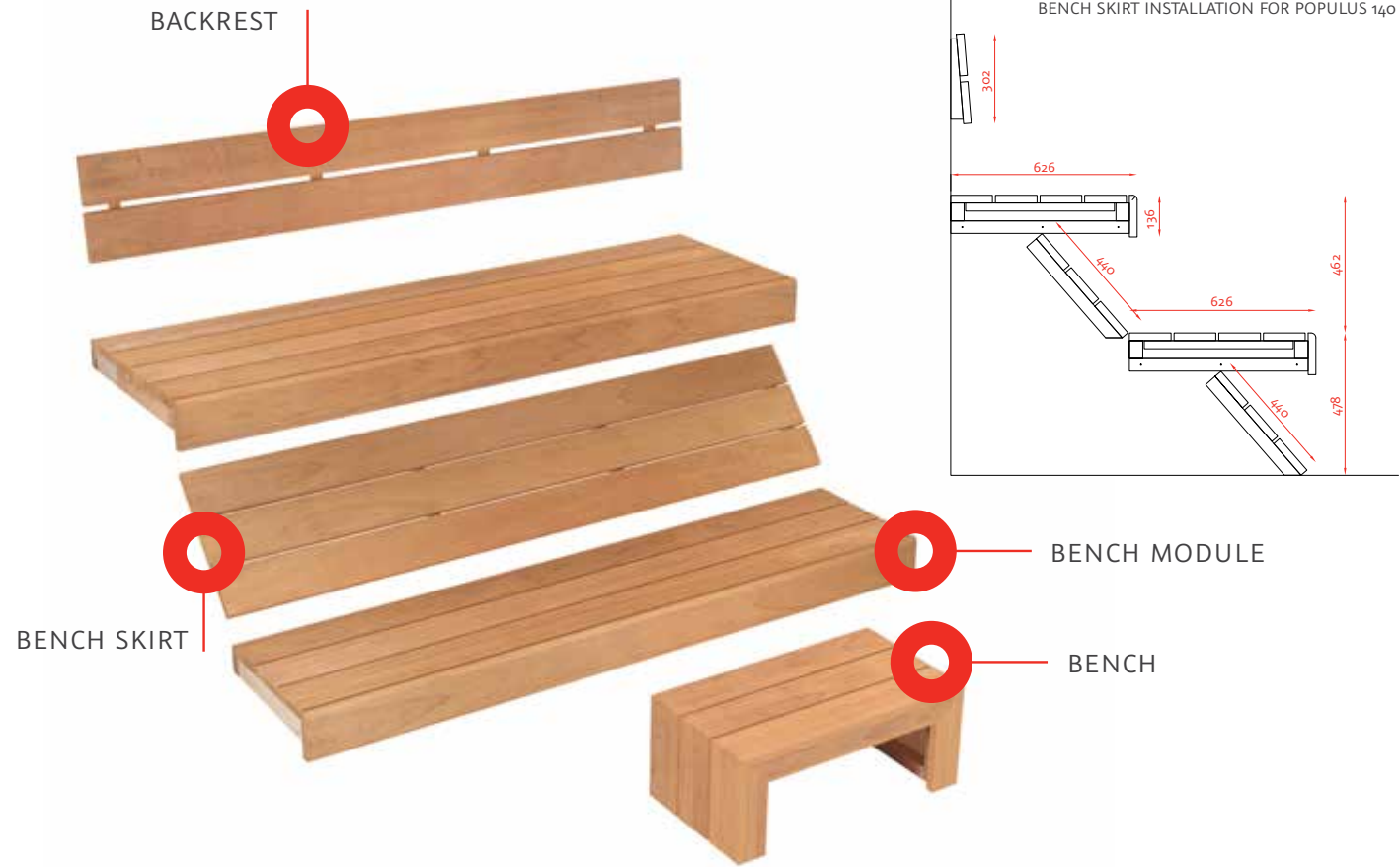

## BENCH MODULES

DIMENSIONS	THERMO-POPLAR
626 x 2100	ST3198
476 x 2100	ST3199

## BACKREST

DIMENSIONS	THERMO-POPLAR
26 x 300 x 2050	ST3201

## BENCH SKIRT

DIMENSIONS	THERMO-POPLAR
26 x 440 x 2100	ST3200

## BENCH

DIMENSIONS (DXWXH)	THERMO-POPLAR
140 / 436 x 800 x 350	ST3202



# Bench set Decora DS 90



EMBOSSED  
NATURAL WOOD

NEW!

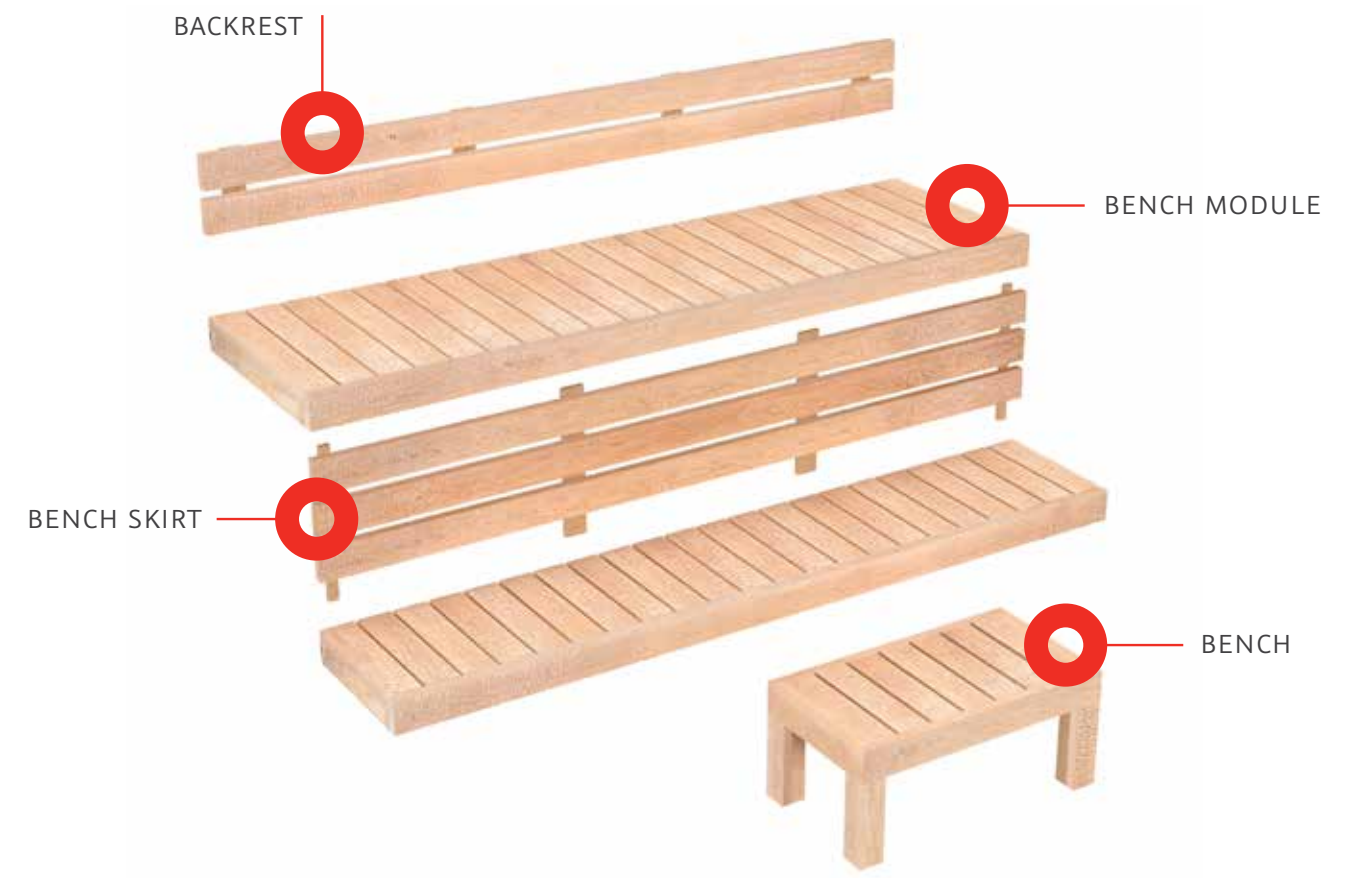

## BENCH MODULES

DIMENSIONS	DRAGON SCALE ALDER
600 x 2100	ST3189
400 x 2100	ST3190

## BACKREST

DIMENSIONS	DRAGON SCALE ALDER
28 x 200 x 2050	ST3192

## BENCH SKIRT

DIMENSIONS	DRAGON SCALE ALDER
28 x 400 x 2100	ST3191

## BENCH

DIMENSIONS (DXWXH)	DRAGON SCALE ALDER
90 / 400 x 730 x 340	ST3194



# Movable benches

Explore Thermory's wide range of movable benches and other furniture for your sauna. With both simple, classical designs and more modern styles available, you can choose the look that suits your sauna best.



DIMENSIONS (DxWxH)	ASPEN	ALDER	THERMO-ASPEN
28 / 300 x 600 x 338	ST0599	ST0598	ST0600



DIMENSIONS (DxWxH)	ASPEN	ALDER	THERMO-ASPEN
28 / 380 x 580 x 350	ST0948	ST1493	ST2037



DIMENSIONS (DxWxH)	ASPEN	ALDER	THERMO-ASPEN
90 / 360 x 1500 x 350	ST2741	ST3156	ST3157



DIMENSIONS (DxWxH)	ASPEN	ALDER	THERMO-ASPEN
134 / 400 x 657 x 300	ST2738	ST2821	ST2766



DIMENSIONS (DxWxH)	ASPEN	ALDER	THERMO-ASPEN
65 / 400 x 800 x 350	ST1017	ST2694	ST2780



DIMENSIONS (DxWxH)	ASPEN	ALDER	THERMO-ASPEN
42 / 380 x 580 x 288	ST1088	ST1807	ST1255

# Movable benches



DIMENSIONS (DxWxH)	ASPEN	ALDER	THERMO-ASPEN
42 / 665 x 580 x 576	ST0744	ST0743	ST2714



DIMENSIONS (DxWxH)	THERMO-RADIATA PINE
135 / 412 x 678 x 300	ST2739



EMBOSED  
NATURAL  
WOOD



NEW!

DIMENSIONS (DxWxH)	DRAGON SCALE ALDER
90 / 400 x 730 x 340	ST3194



NEW!

DIMENSIONS (DxWxH)	THERMO-POPLAR
140 / 436 x 800 x 350	ST3202



DIMENSIONS (DxWxH)	ASPEN	ALDER	THERMO-ASPEN
108 / 460 x 700 x 460	ST0608	ST0607	ST0609
108 / 460 x 1500 x 460	ST2038	ST1026	ST0884



DIMENSIONS (DxWxH)	ASPEN	ALDER	THERMO-ASPEN
140 / 400 x 700 x 350	ST0140	ST0139	ST0141
140 / 400 x 1500 x 350	ST0536	ST0535	ST0537



ROCKING CHAIR

DIMENSIONS (DxWxH)	PINE
1560 x 620 x 870	ST0411



RELAX CHAIR

DIMENSIONS (DxWxH)	ASPEN	ALDER	THERMO-ASPEN
1931 x 620 x 730	ST0854	ST1236	ST0396



DIMENSIONS (DxWxH)	ASPEN	ALDER	THERMO-ASPEN
108 / 380 x 640 x 360	ST1196	ST1197	ST1195
108 / 700 x 640 x 600	ST3368	ST3369	ST3370



DIMENSIONS (DxWxH)	ASPEN	ALDER	THERMO-ASPEN
140 / 650 x 700 x 420	ST0605	ST0604	ST2944
140 / 700 x 700 x 500	ST0593	ST0592	ST0594



DIMENSIONS (DxWxH)	ASPEN	ALDER	THERMO-ASPEN	THERMO-RADIATA PINE
90 / 400 x 670 x 404	ST1368	ST0951	ST1802	
92 / 400 x 704 x 424				ST0950



BENCH WITH BACKREST

TABLE

DIMENSIONS (DxWxH)	ASPEN	ALDER	THERMO-ASPEN
801 x 1476 x 971	ST1809	ST1810	ST0811
492 x 492 x 440	ST0868	ST1808	ST0810



# Arm rests, heater guards, and floor grids



HEATER GUARD

DIMENSIONS (DXWXH)	ASPEN	ALDER	THERMO-ASPEN
28 / 433 x 646 x 650	STo893	STo894	STo892



HEATER GUARD

DIMENSIONS (DXWXH)	ASPEN	ALDER	THERMO-ASPEN
90 / 400 x 600 x 445	STo143	STo142	STo144



HEATER GUARD

DIMENSIONS (DXWXH)	ASPEN	ALDER	THERMO-ASPEN
90 / 800 x 800 x 445	STo194	STo193	STo195



ARM RESTS

DIMENSIONS	ASPEN	ALDER	THERMO-ASPEN
20 x 500 x 1300	STo176	STo175	STo177
20 x 600 x 1300	STo173	STo172	STo174



FLOOR GRIDS

DIMENSIONS	ASPEN	ALDER	THERMO-ASPEN
12 x 600 x 1000	ST1389	ST1390	ST1391
14 x 600 x 1200	STo197	STo196	STo198
14 x 800 x 900	STo200	STo199	STo201



FLOOR GRIDS

DIMENSIONS	THERMO-SPRUCE
15 x 600 x 10000	STo202
15 x 800 x 10000	STo203

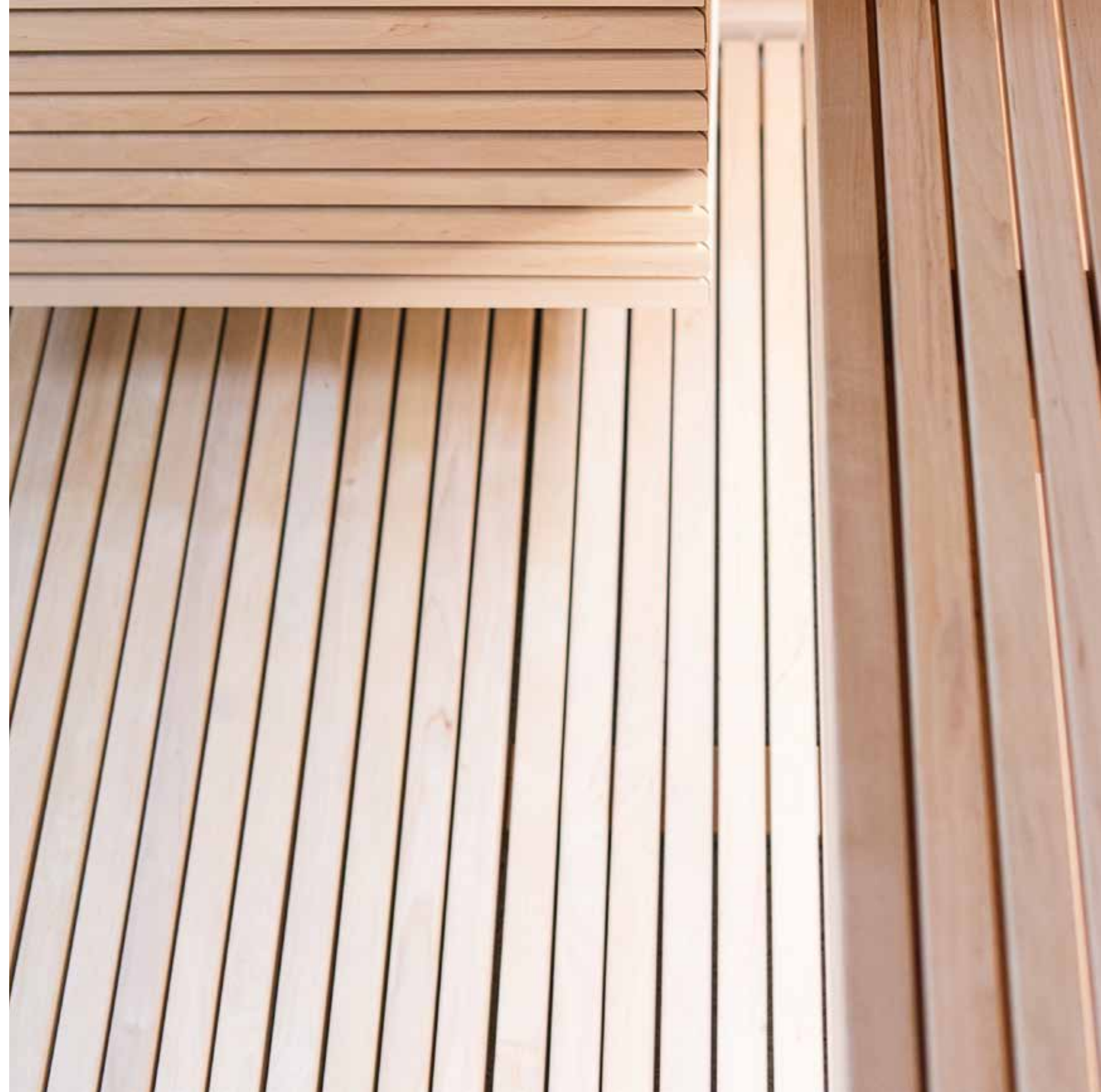



# Sauna and bathroom doors

Thermory's range of sauna and bathroom doors includes several designs in both wood and glass. All of our doors come with a diverse selection of high-quality handles, hinges, and locks to ensure that you can find the right doors for your sauna space.



## TRENDLINE



HINGES  
Abloy bronze



LOCK  
Roller lock



HANDLE  
Trendline



## CLASSIC



HINGES  
Abloy bronze



LOCK  
Roller lock



HANDLE  
Classic



### FRAME 42 x 92



PINE



ASPEN



ALDER

### GLASS 8 MM TEMPERED



CLEAR

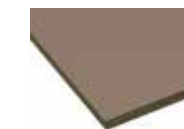

BRONZE

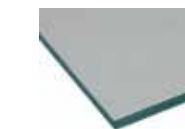

GRAY

All Thermory doors come right-handed as standard but can be altered during installation.

It's also possible to customize your doors with matt glass, special-order handles, specific measurements, and other tailored features – please contact our sales department to find out more about our prices and terms.

# Sauna and bathroom doors

## PREMIUM



### HINGES

Abloy bronze / Abloy gray / RV stainless steel



### LOCK

Roller lock



### HANDLE

Premium wood-metal



### FRAME 42 x 92

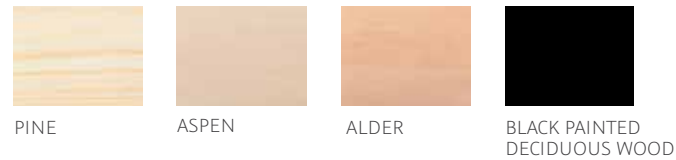

### GLASS 8 MM TEMPERED



## EXCLUSIVE



### HINGES

Abloy bronze



### LOCK

Roller lock



### HANDLE

Exclusive

### FRAME 42 x 92



### GLASS 8 MM TEMPERED



## DOOR DIMENSIONS

Trendline, Classic, Premium, Exclusive

DIMENSIONS	FRAME	GLASS	HINGES
6 x 19	590 x 1890	520 x 1854	2
6 x 20	590 x 1990	520 x 1954	2
6 x 21	590 x 2090	520 x 2054	2
7 x 19	690 x 1890	620 x 1854	2
7 x 20	690 x 1990	620 x 1954	2
7 x 21	690 x 2090	620 x 2054	2
8 x 19	790 x 1890	720 x 1854	2
8 x 20	790 x 1990	720 x 1954	3
8 x 21	790 x 2090	720 x 2054	3
9 x 19	890 x 1890	820 x 1854	2
9 x 20	890 x 1990	820 x 1954	3
9 x 21	890 x 2090	820 x 2054	3

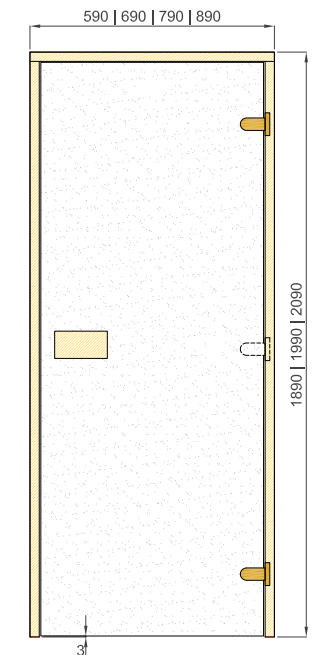

# Sauna and bathroom doors

## MAGNETIC LOCK DOOR



**HINGES**  
RV stainless steel



**LOCK**  
Magnetic lock

**HANDLE**  
Aspen, alder



**FRAME 42 x 92**

**BATHROOM**



PINE



ASPEN



ALDER



WHITE PAINTED  
DECIDUOUS WOOD

**GLASS 8 MM TEMPERED**



CLEAR

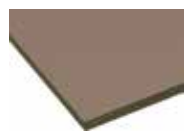

BRONZE

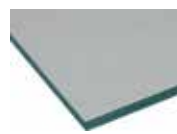

GRAY

## BATHROOM DOOR



**HINGES**  
Abloy FL75 gray



**LOCK**  
Keyless lock

**HANDLE**  
Hoppe A1530



**MAGNETIC LOCK DOOR DIMENSIONS**

DIMENSIONS	FRAME	GLASS	HINGES
7 x 19	690 x 1890	620 x 1854	2
8 x 19	790 x 1890	720 x 1854	2
9 x 19	890 x 1890	820 x 1854	2

**BATHROOM DOOR DIMENSIONS**

DIMENSIONS	FRAME	GLASS	HINGES
7 x 21	690 x 2090	620 x 2054	2
8 x 21	790 x 2090	720 x 2054	3
9 x 21	890 x 2090	820 x 2054	3

## STEAM SAUNA DOOR



**HINGES**  
Abloy gray



**LOCK**  
Roller lock



**HANDLE**  
Trendline metal / Premium metal-metal



**FRAME 42 x 70**



ALUMINUM

**GLASS 8 MM TEMPERED**



CLEAR



BRONZE

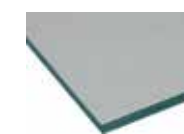

GRAY

DIMENSIONS	FRAME	GLASS	HINGES
7 x 19	690 x 1890	620 x 1854	2
7 x 20	690 x 1990	620 x 1954	2
7 x 21	690 x 2090	620 x 2054	2
8 x 19	790 x 1890	720 x 1854	2
8 x 20	790 x 1990	720 x 1954	3
8 x 21	790 x 2090	720 x 2054	3
9 x 19	890 x 1890	820 x 1854	2
9 x 20	890 x 1990	820 x 1954	3
9 x 21	890 x 2090	820 x 2054	3



# Wooden doors

## SAILOR

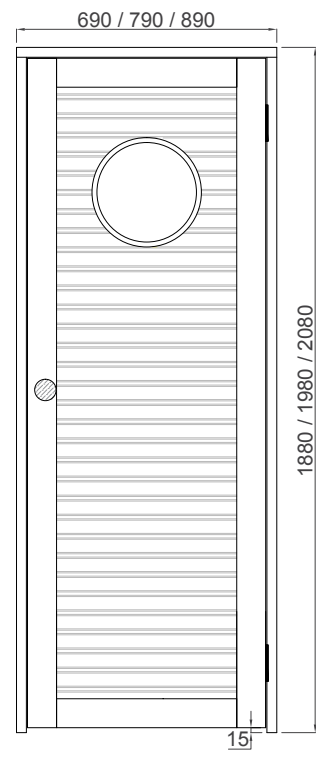

LOCK  
Roller lock



HANDLE  
Trendline



FRAME 42 x 92, DOOR PANELING STP 15 x 90



GLASS 8 MM TEMPERED



DIMENSIONS
7 x 19
7 x 20
7 x 21
8 x 19
8 x 20
8 x 21
9 x 19
9 x 20
9 x 21

**NOTE: This door is unsuitable for rooms that can become humid**

## FOREST

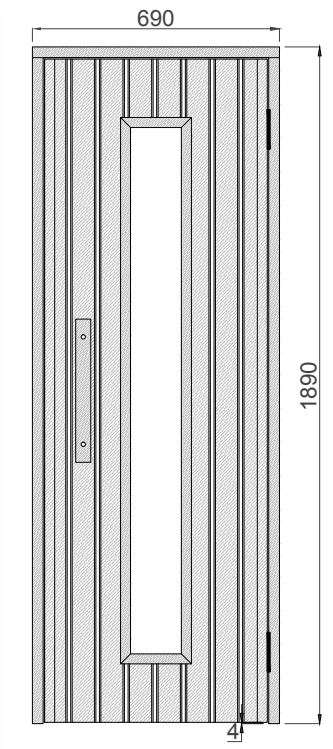

LOCK  
Roller lock



HANDLE  
Wood

FRAME 42 x 92, PANELING STP 15 x 90



GLASS 8 MM TEMPERED



DIMENSIONS
7 x 19

**NOTE: This door is unsuitable for rooms that can become humid**

# Sauna windows and door mouldings

## SAUNA WINDOW

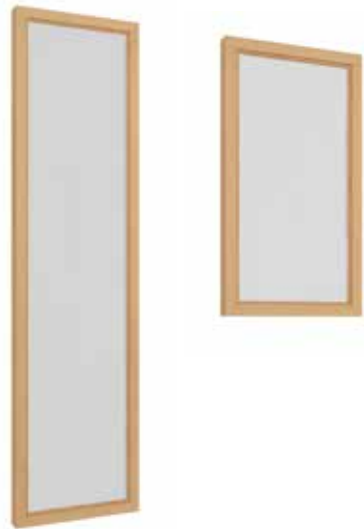

DIMENSIONS	FRAME mm
5 x 9	490 x 890
5 x 19	490 x 1890

FRAME 42 x 92



GLASS 8 MM TEMPERED



## DOOR MOULDINGS SET



SET 5200	SET 6000
2 x 2100 mm	2 x 2400 mm
1 x 1000 mm	1 x 1200 mm

PROFILE UK 12 x 42



Thermory door mouldings sets are easy to use – the mouldings are cut to standard lengths and the ends are pre-cut to the correct angle, making them quick and easy to install or adjust.

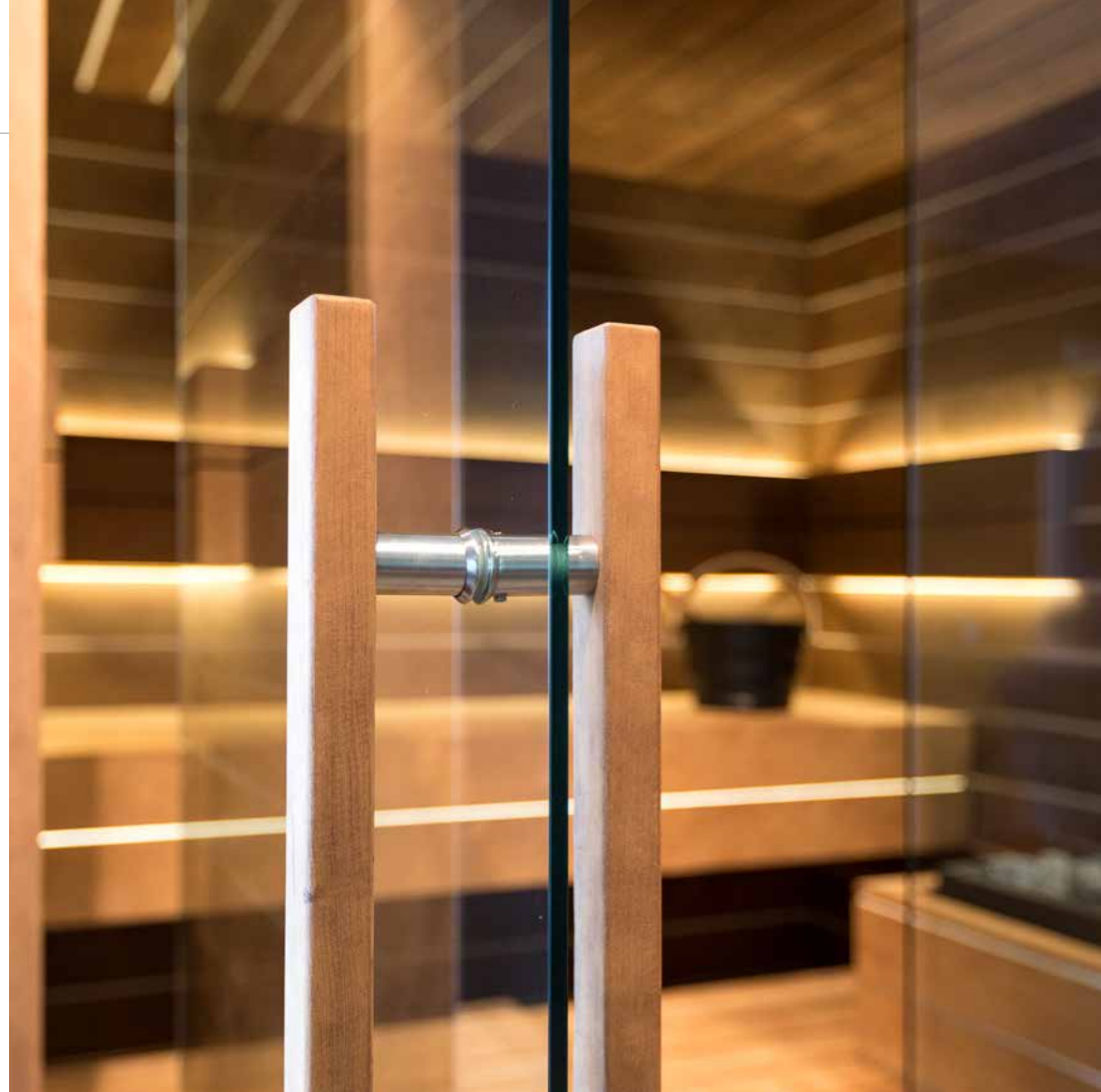

## LIGHTING

DIMENSIONS	ASPEN	ALDER	THERMO-ASPEN
55 x 220 x 280	STo635	STo634	STo636



## LIGHTING COVERS

DIMENSIONS	ASPEN	ALDER	THERMO-ASPEN
1 100 x 250 x 270	STo002	STo001	STo003
2 100 x 300 x 300 C	STo005	STo004	STo006
3 140 x 240 x 400 C	STo008	STo007	STo009

Covers 2 and 3 are suitable for corner walls



## HEADRESTS

DIMENSIONS	ASPEN	ALDER	THERMO-ASPEN
1 90 x 290 x 400	STo014	STo013	STo015
2 80 x 280 x 360	ST2261	ST2260	ST2262
3 80 x 310 x 360	STo023	STo022	STo024
4 84 x 258 x 68	STO0369		



## SEAT RESTS

DIMENSIONS	ASPEN	ALDER	THERMO-ASPEN
1 14 x 230 x 440	STo026	STo025	STo027
2 16 x 290 x 405		STO0370	



## VENTILATION HATCHES

DIMENSIONS	ASPEN	ALDER	THERMO-ASPEN
133 x 282	STo032	STo031	STo033



## VENTILATION GRIDS

DIMENSIONS	ASPEN	ALDER	THERMO-ASPEN
1 150 x 190	STo029	STo028	STo030
2 145 x 225	STo343	STo342	STo344



## TOWEL RACKS

DIMENSIONS	ASPEN	ALDER	THERMO-ASPEN
136 x 164 x 612	ST1938	ST1937	ST1939

Glass: 8 mm tempered, bronze



## BUCKET AND LADLE

PRODUCT	PRODUCT CODE
Wooden bucket, plastic interior – 4 liters	STO0008
Ladle	STO0010





# A guide to installing and maintaining your Thermory sauna

When constructing a sauna, it must be installed with high levels of quality and precision in order to protect the wood's features and durability. As an organic material, wood also needs regular maintenance to preserve its natural qualities for longer. A selection of installation and maintenance guidelines is available on the Thermory website, and you can contact our sales department whenever you have any questions.

### What's included in this guide:

- ▶ Sauna installation guidelines
- ▶ Advice for sauna maintenance
- ▶ Suggestions for using intensely thermally modified wood
- ▶ Recommended maintenance supplies

## Sauna installation guidelines

### PREPARING FOR INSTALLATION

- ▶ Read the user manuals for the sauna materials and the installation guides for all electrical devices to be used
- ▶ Check that there is adequate ventilation in the room where the sauna is to be installed
- ▶ Make sure that the wooden materials won't come into constant contact with water, for instance at the bottom of the wall, during installation
- ▶ Ensure that the external surfaces of the sauna won't remain exposed to water or moisture upon installation
- ▶ Ensure that any electrical work, including installation of the electric sauna heater, is done by a licensed electrician

### TREATING WOODEN COMPONENTS

- ▶ To prolong the life of your sauna, Thermory recommends that you treat all wooden components, elements, and frames with a breathable wood preservative – preservatives improve the wood's resistance to dirt and moisture, making it easier to clean and enhancing its appearance with a deep, vivid tone
- ▶ Dust all of the wooden sauna components and then clean them with a sauna detergent before allowing them to dry
- ▶ Treat the walls and ceilings on both sides with a specialist sauna finish product such as Tikkurila Supi Saunasuoja and then treat all surfaces of the seating materials with a sauna bench protection product like Tikkurila Supi Laudesuoja
- ▶ Don't use paints or varnishes, as the wood must be able to breathe

### INSTALLING THE HEATER AND HEATING STONES

- ▶ Ensure that the heater is installed according to the manufacturer's instructions
- ▶ Install the heating stones as directed by the manufacturer and make certain that the heating elements aren't visible, as pouring water directly onto them can reduce their lifespan
- ▶ Wash the heating stones to remove any production chemicals
- ▶ Important – do not use your sauna when heating it for the first time!
- ▶ During the first heating, do so under supervision to a temperature of about 100°C for two hours, keeping the sauna well ventilated both during and after heating; the heat will cause the wood to absorb the treatment products, which will form a protective layer

## Advice for sauna maintenance

### DURING USE

- ▶ Only throw water on the heater, not on the walls or benches
- ▶ Don't wear wet swimsuits in the sauna, as water from these will damage the bench
- ▶ To keep the bench fresh, we recommend using seat covers – these can also make it more comfortable to sit on the bench when it is hot
- ▶ Keep an eye on the heating stones, as they may crack over time – whenever necessary, they can be replaced or more stones can be added

### AFTER EACH USE

- ▶ Wipe the benches with a clean, damp cloth – don't use running water to clean them, and ensure that excess water doesn't pool on the wooden surfaces
- ▶ Use appropriate cleaning products for the benches and other wooden components, reading the instructions first
- ▶ After cleaning your sauna, allow the surfaces to dry and ensure that the room is well ventilated – we recommend leaving the heater on for at least half an hour with the air vent open and the door and windows closed
- ▶ If possible, lift up the benches to allow them to dry better

### AT LEAST ONCE PER YEAR

- ▶ Treat the sauna's wooden surfaces with an appropriate product (see *Treating wooden components* above) – this should be done more frequently if the sauna receives intensive use
- ▶ Clean all surfaces of the seating materials, walls, and ceilings using a soft brush or cloth and a specialist cleaning product, following the instructions on the packaging
- ▶ For deeper stains and soiling, gently clean the bench using a fine sandpaper before treating the sanded surface with a wood preservative (see *Treating wooden components*)
- ▶ Avoid using cleaning agents that are unsuitable for saunas – for example, disinfectants bleach the wood and can spoil its surface
- ▶ Inspect the fastenings on the benches and supports, tightening any screws if necessary; they may loosen over time due to changes in the wood caused by heat and humidity

### THINGS TO AVOID

- ▶ Don't dry textiles in your sauna, as this can be a fire hazard – excessive moisture can also damage the surface of the wood
- ▶ Avoid heating the sauna beyond the maximum temperature specified by the heater manufacturer – excessive heat may create a fire risk or cause the wood to warp
- ▶ Never use a pressure washer or running water when cleaning your sauna, as excessive moisture can permanently damage the structure and surface of the wood

### HOW WOOD CHANGES WHEN USED IN THE SAUNA

- ▶ Wood is a natural material, and its surface may crack or bend when used in the sauna
- ▶ This is normal due to the extreme and rapid changes in temperature and humidity that occur
- ▶ The risk of wood deformation depends on the material and intensity of use – the effects are also more visible in wider boards
- ▶ Wooden materials in the part of the sauna most exposed to the hot steam may darken over time
- ▶ When new, thermally modified wood may give off a noticeable scent as the sauna is heated, but this will diminish over time

## Suggestions for using intensely thermally modified wood

Thermory's range of wooden sauna products includes a large selection of thermally modified products. Of these, the most exclusive and luxurious items are made with wood that has undergone intense thermal modification, which gives it a beautiful rich brown color, such as dark alder and radiata pine. These elegant materials can be sensitive, and they require special care and attention to maintain their appealing properties.

- ▶ Handle packs of wood or individual boards with care during installation
- ▶ Don't scratch the surface of the wood or slide the boards over one another
- ▶ Thermally modified wood has a distinctive scent that diminishes over time but never fully vanishes – however, it will lose this scent more quickly if the sauna is heated for an extended period while being ventilated
- ▶ Treating the wood with a suitable wood oil or care product will also soften the scent
- ▶ Avoid washing untreated thermally modified wood with water, as this will intensify the scent
- ▶ Please note that we cannot accept claims about the quality or scent of the wood after it has been cut, installed, or treated

## Recommended maintenance supplies



Supi Saunasuoja  
Sauna protection 0.9 L  
STO0135



Supi Saunasuoja  
Sauna protection 2.7 L  
STO0136



Supi Laudesuoja  
Bench protection oil 1.0 L  
STO0131



Supi Saunapesu  
Cleanser 1.0 L  
STO0132



# Saunas love Thermory

Thermory has been providing world-class materials to the spa and sauna industries for over 20 years. Here is a selection of public facilities and homes where our products have been used, helping thousands of bathers reach a state of wellness and relaxation.





A sauna designed with dark thermally modified alder walls STS10 15 x 65 mm, natural aspen ceiling STS10 15 x 68 mm, and benches SHP 28 x 90 mm. PRIVATE SAUNA, ESTONIA



A combined infrared and traditional sauna with walls STP 15 x 90 mm and benches SHP 28 x 90 mm, in natural aspen. PRIVATE SAUNA, GERMANY





One of a series of spacious saunas using various panels and boards in natural alder – walls STS10 15 x 90 mm and benches SHP 28 x 65 mm. VABALI SPA, GERMANY



A beautiful sauna combining natural aspen panels with special rustic-looking woods – walls STS10 15 x 90 mm and benches SHP 21 x 21 mm. UTHLAND SPA, GERMANY





This sauna presents an elegant combination of dark thermally modified brushed alder and light natural aspen – walls STS10 15 x 120 mm, bench skirt with backrest SHP 28 x 85 mm, and benches SHP 28 x 90 mm. PRIVATE SAUNA, ESTONIA



A simple yet extremely cozy and comfortable sauna made with thermally modified poplar – walls STS4 15 x 140 mm and benches SHP 28 x 140 mm. PRIVATE SAUNA, BELGIUM





A practical sauna design with a large capacity, made with thermally modified magnolia – walls STS3 15 x 185 mm and benches 28 x 185 mm. PRIVATE SAUNA, ESTONIA



With a little ingenuity, a sauna can fit anywhere; natural alder – walls STS 15 x 90 mm and benches SHP 27 x 27 mm. PRIVATE SAUNA, GERMANY

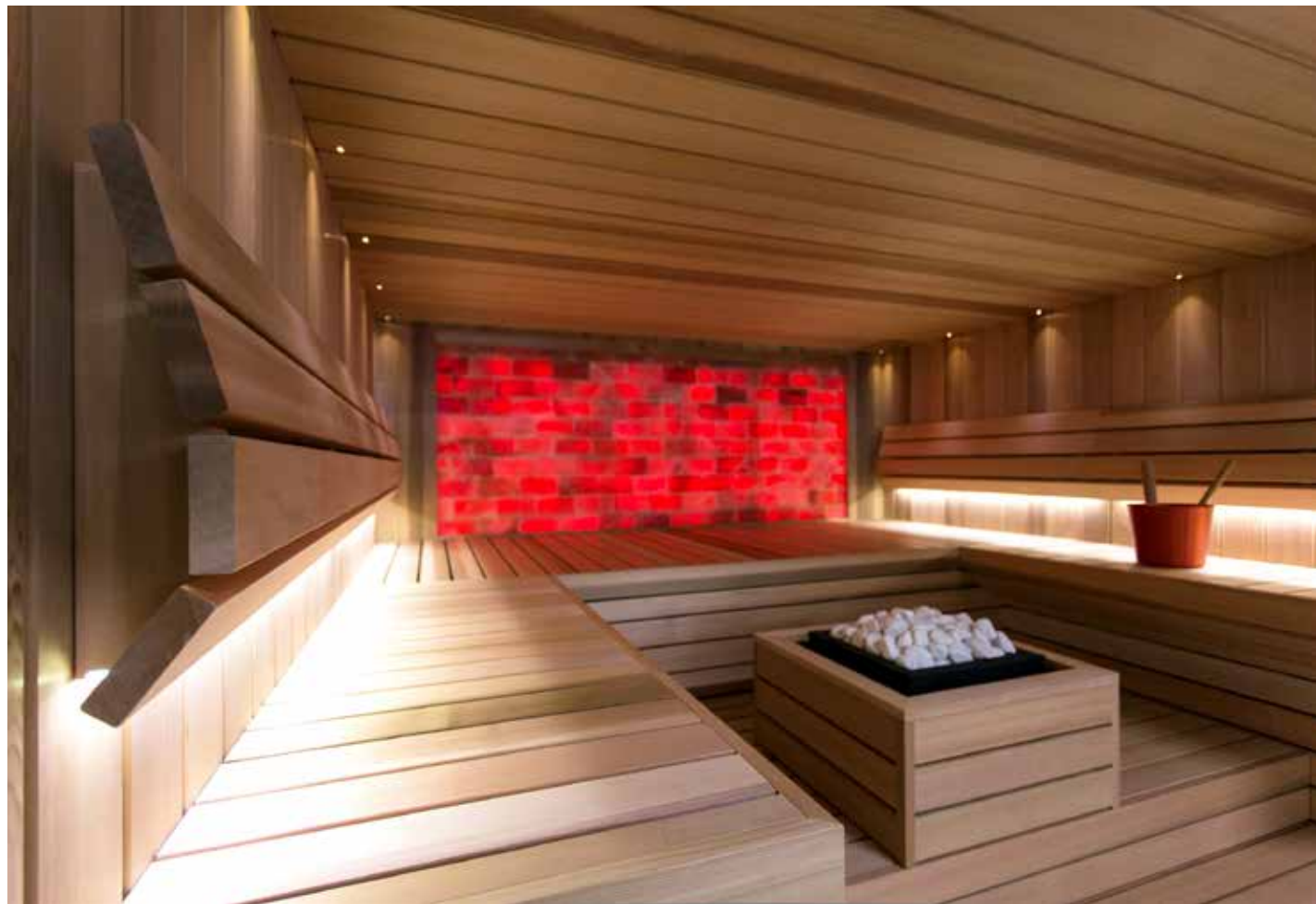

Cedar and salt brick sauna – walls STP 15 x 140 mm and benches SHP 26 x 90 mm.  
PRIVATE SAUNA, ITALY



A unique design featuring natural alder panels painted with a special black sauna wax – walls STS4 15 x 140 mm and benches SHP 28 x 90 mm. PRIVATE SAUNA, UNITED KINGDOM





A stunning combination of wall panels in thermally modified radiata pine, STS4 19 x 185 mm and benches in natural aspen, SHP 28 x 90 mm. PRIVATE SAUNA, GERMANY



This sauna, at a gorgeous indoor beach hall with white sand, a beach lounge, and multiple saunas, is made with thermally modified magnolia with different widths – STS10 15 x 170 mm, 15 x 145 mm, and 15 x 68 mm. TERAS BEACH, ESTONIA





A stylish black-and-white sauna made with painted natural radiata pine panels – walls STS4 19 x 185 mm and benches SHP 26 x 90 mm and 26 x 140 mm. PRIVATE SAUNA, FINLAND



A special design with thermally modified aspen wall panels, STP 15 x 90 mm alongside SRP 15 x 82 mm, and thermally modified radiata pine bench modules SHP 26 x 140 mm. QUALITY HOTEL LAPLAND, SWEDEN



This sauna features a wonderful rustic look, which was achieved by using unedged dark thermally modified alder. PRIVATE SAUNA, ESTONIA



A traditional sauna with an edgy, modern twist made with thermally modified aspen – walls STS10 15 x 68 mm and benches 28 x 65 mm. FAMILIA SAUNA FROM THE AUROOM DESIGN SERIES, SWITZERLAND





A beautiful sauna with dark benches that contrast with the light walls – exterior wall panels STS4 18 x 180 mm in thermally modified ash, interior wall panels STS4 15 x 120 mm in natural aspen, and benches SHP 28 x 135 mm in dark thermally modified alder. PRIVATE SAUNA, NETHERLANDS



This gorgeous sauna features wall panels with end matching and STF profile – length 293 mm with three different widths: 65, 85, and 120 mm. ELECTA SAUNA FROM THE AUROOM DESIGN SERIES, SWITZERLAND





## Other products by Thermory

In addition to Thermory sauna materials and ready-made elements, we also offer a number of other high-quality products, including Auroom ready-made saunas, thermally modified wood products for exterior and interior use by Thermory, and an exceptional range of painted wood products under the Siparila brand.

## Ready-made saunas

Our AUROOM brand is dedicated to providing complete solutions, with a range of inspiring designs to choose from and ready-made saunas that can be created to your exact specifications.

### TAILOR-MADE SAUNAS AND STANDARD DESIGNS FOR PRIVATE AND PUBLIC PROJECTS

- Traditional saunas • Infrared saunas
- Outdoor saunas • Equipment and Accessories



See more at  
[auroomwellness.com](http://auroomwellness.com)





## Thermally modified decking, cladding, and flooring

Thermory brings together sustainability, function, and beauty to create thermally modified wood products that offer unrivaled durability and visual appeal. Alongside the sauna materials found in this catalogue, we also offer a range of quality products for home improvements and large-scale construction projects with innovations that enable a quick, easy, and seamless installation.

Our thermally modified wood products include:

- ▶ CLADDING
- ▶ DECKING
- ▶ WALL COVERINGS
- ▶ FLOORS



See more at  
[thermory.com](https://thermory.com)





# SIPARILA

## Fully finished paneling

Exquisite Finnish craftsmanship, superior design, and a deep respect for nature come together in Siparila's exterior and interior wooden panels, which can be used to create impressive designs and inspirational features for the home. Our products offer safe, sustainable, and healthy lifestyles for future generations, with fast and versatile ways of designing and building indoor and outdoor spaces.

Let the wood inspire you to bring your ideas into reality!

Siparila's product portfolio includes:

- PAINTED CLADDING
- INTERIOR PANELS
- SAUNA MATERIALS



See more at  
[siparila.com](http://siparila.com)



# The Thermory reach

We have been distributing our unrivaled thermally modified wood for over 20 years, with more than 20 million square meters of Thermory products now installed worldwide. Our headquarters are in Estonia, with daughter companies in the USA, Finland and Belarus, and our reach is global.

Thermory  
USA

Thermory  
Estonia  
Finland

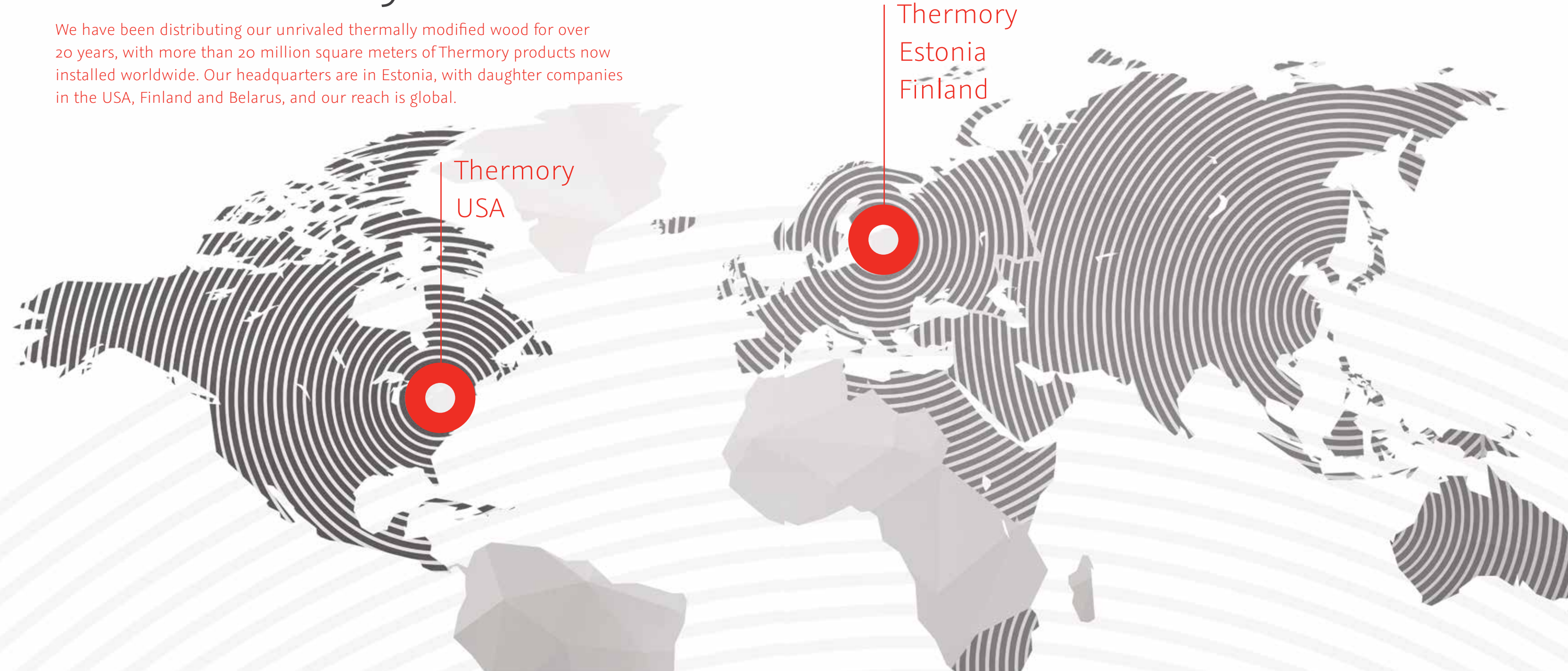



THERMORY



For more information and reference photos, please visit  
[Thermory.com](https://thermory.com)

Ready to start your project? Get in touch at  
[sauna@thermory.com](mailto:sauna@thermory.com)



Thermory



Thermory



Thermorydesign



Thermory AS

Copyright 2020 Thermory AS  
All rights reserved.  
Please check technical details prior to purchase.



©Ecoprint



4041 0799  
Printed matter

